



**PB SERIES HYDRAULIC PRESS BRAKE
E21 CONTROLLER**

OPERATION MANUAL



www.machineryhouse.com.au

CONTENTS

1.1.MAIN APPLICATION.....Page 2

1.2 DESCRIPTION.....Page 3

1.3 FUNDAMENTAL DATA.....Page 5

1.4 MACHINE STRUCTURE.....Page 10

2.1 INSTALLATION.....Page 16

2.2 SAFETY.....Page 19

2.3 COMMISSIONING.....Page 22

2.4 ELECTRICAL CONNECTION.....Page 23

2.5 CONTROLS.....Page 24

2.6 LIGHT CURTAINPage 27

2.7 TRIAL RUN & OPERATION.....Page 29

3.1 BENDING TECHNIQUES.....Page 30

3.2 ADJUSTMENT OF LOWER & UPPER LIMIT OF THE RAM.....Page 32

4.1 LUBRICATION.....Page 33

4.2 HYDRAULIC SYSTEM.....Page 34

ELECTRICAL DIAGRAMS.....Page 37

CERTIFICATE OF QUALITY.....Page 43

APPENDIX.....Page 46

- FOLDSAFE LIGHT CURTAIN

- E21 CONTROL;LER MANUAL

- RISK ASSESSMENT SHEETS

Contents

This operating manual is for the Metalmaster PB series press brakes.

All operators should read this operating manual carefully and only then operate the machine.

The machine must only be operated according to the specification limits.

All safety precautions should be observed and care must be taken when operating the machine

Read the manual carefully so you have a thorough knowledge of this machine.

Follow the installation, maintenance and operating instructions listed in this manual to avoid the risk of injury to the operator or damage to the machine. Refer to the risk assessment sheets and safety requirements contained in the manual

Keep this manual in a safe location, and refer to it whenever necessary.

1.1.MAIN APPLICATION

The METALMASTER press brake can be used to bend various kinds of sheet metal. The machine is suitable for the manufacturing of components for the aviation, ship building, automobile and electric appliance industries, and has high efficiency in production. The machine is supplied with one set of dies, but when fitted with optional dies, the operator can bent many different shapes on the work pieces. (Fig.1)

Fig.1

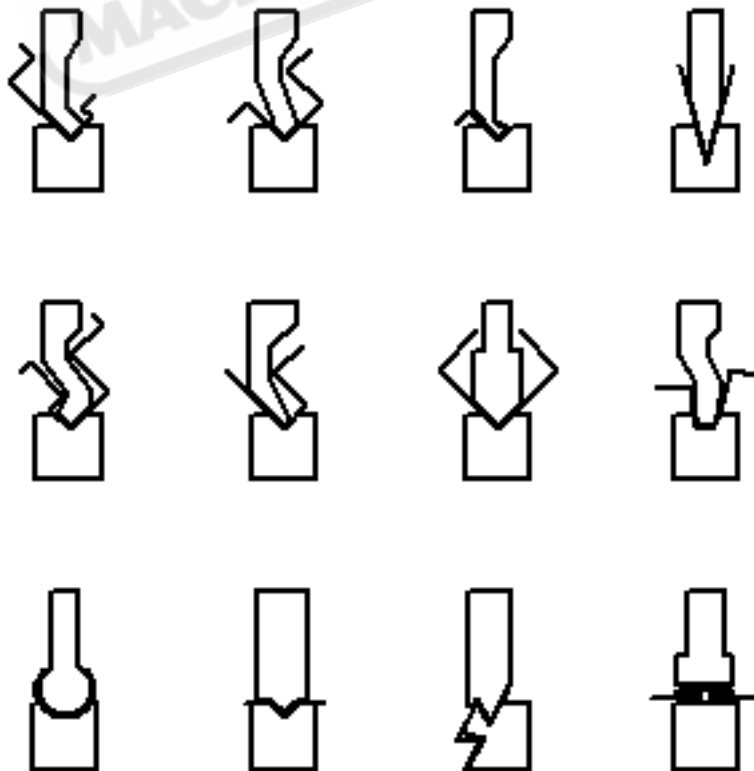

1.2 DESCRIPTION

The purpose of this document is to help with the installation and operation of your Metalmaster hydraulic press brake and its connection to the electrical supply systems.

Metalmaster PB hydraulic press brakes are down stroking machines equipped with a controller that allows for the positioning of the “X” and “Y” axis, to produce all the bending angles required.

The product manual includes the following models:

- PB-40B (44tons x 2 meter)
- PB-70B (70tons x 3.2 meter)
- PB-135B (135tons x 3.2 meter, 4 meter)
- PB-170B (176tons x 3.2 meter, 4 meter,)
- PB-200B (220tons x 3.2 meter, 4 meter,)

The Metalmaster Press brake is supplied with range of NC controllers

- NC E21 Estun Controller
- or
- CNC Fastfold

All models are delivered:

- In a basic version with light curtain fitted,

or

- Foldsafe Light Curtain

The Metalmaster PB press brakes are equipped with a torsion bar system to ensure bending quality, along with an electro hydraulic solenoid valve system, that controls the travel and ensures that the beam remains perfectly parallel to the die table Metalmaster machines can be equipped with various options such as back gauge, front gauge, etc.

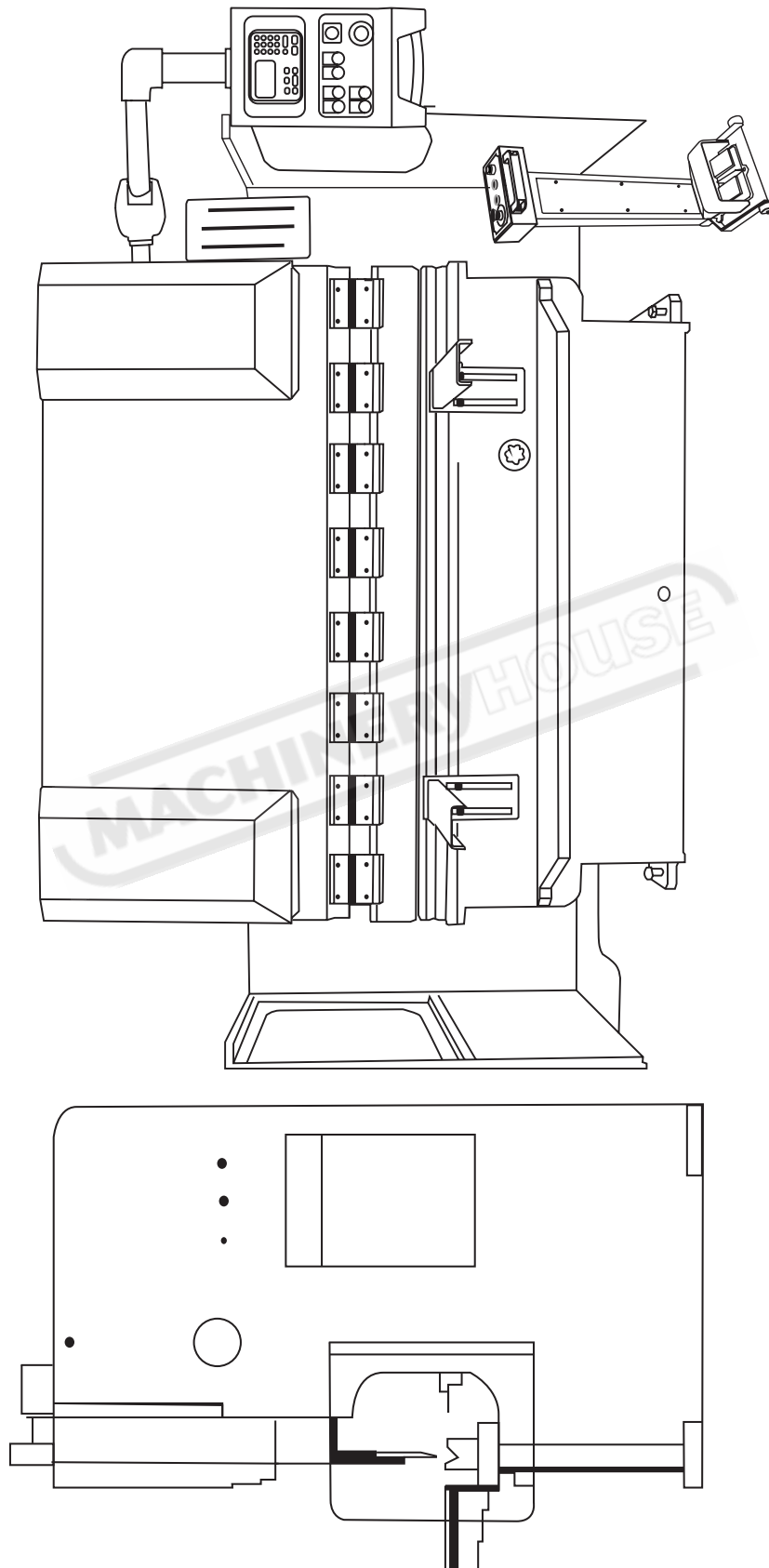
Machine Diagram

1.3 FUNDAMENTAL DATA

Model PB-40B

No.	Name	Value	Unit	Remark	
1	Nominal Pressure	400	k N		
2	Nominal Pressure	44	Ton		
3	Working table length	2000	mm		
4	Distance between uprights	1615	mm		
5	Throat depth	200	mm		
6	Stroke	100	mm		
7	Distance table/ram	330	mm		
8	Max.stroke of block	80	mm		
9	Speed for slide Stroke	Approach	60	mm/s	
		Working	≤10	mm/s	
		Return	48	mm/s	
10	Oil pump	Type	NT2-G10F		
		Flow	10	ml/r	
		Pressure	32	Mpa	
11	Main motor	Type	Y132M1-6		B35
		Power	4	Kw	
12	Motor for adjusting slide block	Type	GS7136		
		Power	0.37	Kw	
13	Motor for adjusting back gauge	Type	Y802-6		
		Power	0.55	Kw	
14	Overall dimension	L	2800	mm	
		W	1535	mm	
		H	2030	mm	
15	Max,working pressure for the hydraulic system	21.5	Mpa		

1.3 FUNDAMENTAL DATA

Model PB-70B

No.	Name	Value	Unit	Remark	
1	Nominal Pressure	630	k N		
2	Nominal Pressure	70	Ton		
3	Working table length	3200	mm		
4	Distance between uprights	2600	mm		
5	Throat depth	250	mm		
6	Stroke	120	mm		
7	Distance table/ram	360	mm		
8	Max.stroke of block	75	mm		
9	Speed for slide Stroke	Approach	60	mm/s	
		Working	≤10	mm/s	
		Return	41	mm/s	
10	Oil pump	Type	NT2-G16F		
		Flow	16	ml/r	
		Pressure	32	Mpa	
11	Main motor	Type	Y132M2-6		B35
		Power	5.5	Kw	
12	Motor for adjusting slide block	Type	GS7136		
		Power	0.37	Kw	
13	Motor for adjusting back gauge	Type	Y802-6		
		Power	0.55	Kw	
14	Overall dimension	L	4000	mm	
		W	1635	mm	
		H	2345	mm	
15	Max,working pressure for the hydraulic system	21	Mpa		

1.3 FUNDAMENTAL DATA

Model PB-135B

No.	Name	Value	Unit	Remark	
1	Nominal Pressure	1250	k N		
2	Nominal Pressure	135	Ton		
3	Working table length	3200/4000	mm		
4	Distance between uprights	2600/3200	mm		
5	Throat depth	420	mm		
6	Stroke	120	mm		
7	Distance table/ram	380	mm		
8	Max.stroke of block	100	mm		
9	Speed for slide Stroke	Approach	60	mm/s	
		Working	≤ 10	mm/s	
		Return	38	mm/s	
10	Oil pump	Type	NT2-G25F		
		Flow	25	ml/r	
		Pressure	32	Mpa	
11	Main motor	Type	Y160M-6		B35
		Power	7.5	Kw	
12	Motor for adjusting slide block	Type	GS7136		
		Power	0.37	Kw	
13	Motor for adjusting back gauge	Type	Y802-6		
		Power	0.55	Kw	
14	Overall dimension	L	4000/4800	mm	
		W	1695	mm	
		H	2590	mm	
15	Max,working pressure for the hydraulic system	25	Mpa		

1.3 FUNDAMENTAL DATA

Model PB-170B

No.	Name	Value	Unit	Remark	
1	Nominal Pressure	1600	k N		
2	Nominal Pressure	176	Ton		
2	Working table length	3200/4000	mm		
3	Distance between uprights	2600/3200	mm		
4	Throat depth	420	mm		
5	Stroke	200	mm		
6	Distance table/ram	470/480	mm		
7	Max.stroke of block	160	mm		
9	Speed for slide Stroke	Approach	60	mm/s	
		Working	≤10	mm/s	
		Return	48	mm/s	
10	Oil pump	Type	NT2-G25F		
		Flow	25	ml/r	
		Pressure	32	Mpa	
11	Main motor	Type	Y160M-4		B35
		Power	11	Kw	
12	Motor for adjusting slide block	Type	GS7136		
		Power	0.37	Kw	
13	Motor for adjusting back gauge	Type	Y802-6		
		Power	0.55	Kw	
14	Overall dimension	L	4000/4800	mm	
		W	1755/1955	mm	
		H	2735/2815	mm	
15	Max,working pressure for the hydraulic system	23.5	Mpa		

1.3 FUNDAMENTAL DATA

Model PB-200B

No.	Name	Value	Unit	Remark	
1	Nominal Pressure	2000	Kn		
2	Nominal Pressure	220	Ton		
2	Working table length	4000	mm		
3	Distance between uprights	3200	mm		
4	Throat depth	420	mm		
5	Stroke	200	mm		
6	Distance table/ram	470	mm		
7	Max.stroke of block	160	mm		
9	Speed for slide Stroke	Approach	60	mm/s	
		Working	≤10	mm/s	
		Return	44	mm/s	
10	Oil pump	Type	NT2-G25F		
		Flow	25	ml/r	
		Pressure	32	Mpa	
11	Main motor	Type	Y160L-4		B35
		Power	15	Kw	
12	Motor for adjusting slide block	Type	GS7136		
		Power	0.37	Kw	
13	Motor for adjusting back gauge	Type	Y802-6		
		Power	0.55	Kw	
14	Overall dimension	L	4800	mm	
		W	1960	mm	
		H	2805	mm	
15	Max,working pressure for the hydraulic system	24.5	Mpa		

1.4.MACHINE'S STRUCTURE

The main parts of the machine are made of steel plates joined together by structurally approved welding, which ensures its high density, rigidity and lightness in weight. It is composed of the following parts:

1. Framework

The rack-shaped framework is composed of left and right sides fabricated from steel plates. The oil tank is positioned above the beam near the rams. The beam is supported by the uprights via the two hydraulic cylinders. Four sets of adjustable brass pads ensures the perfect guiding of the beam, and provide the means for axial adjustment.

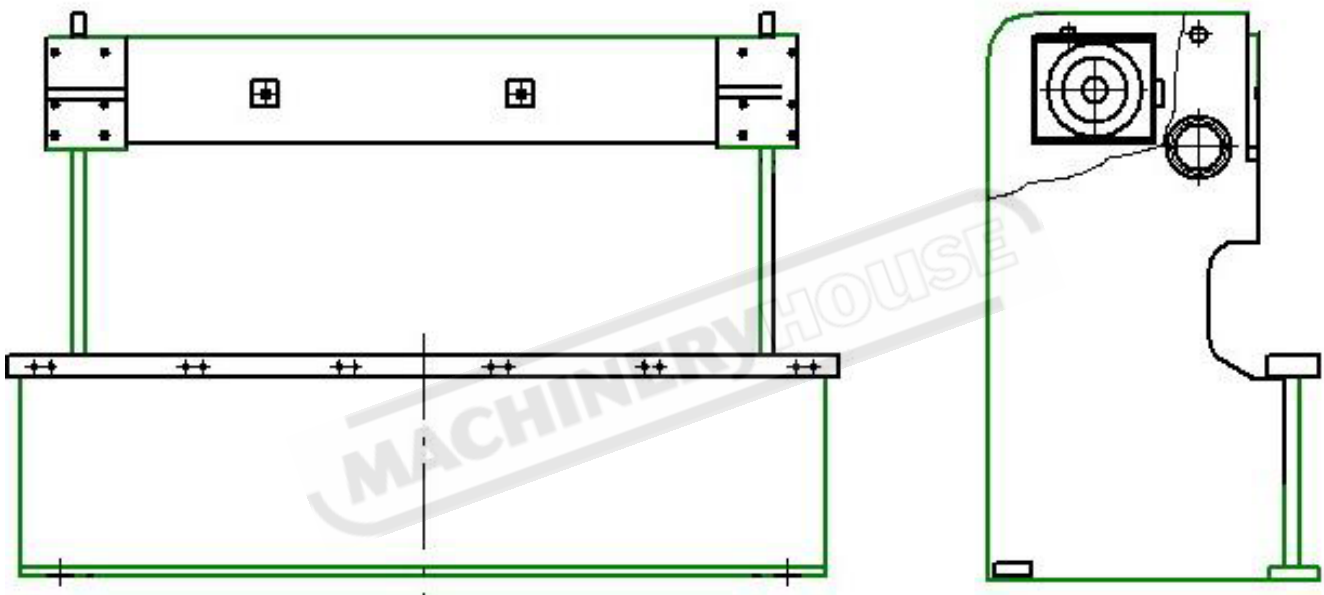

The rams are made of a whole piece of steel plate. They are connected through the piston rods
Oil cylinders are fixed on the upper part of the left and right sides.

The ram is moved up and down by the piston driven through hydraulic pressure

2) There are two hydraulic cylinders. Their purpose is to transmit the required bending force to the beam, and to provide lateral guidance.

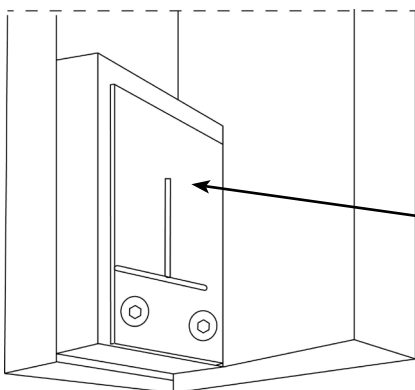

The beam is guided by brass pads attached to the structure with a small amount of adjustment available. This produces a smooth seamless movement

Brass Pad

Fig 3. Assembly drawing of stroke adjustment for the ram

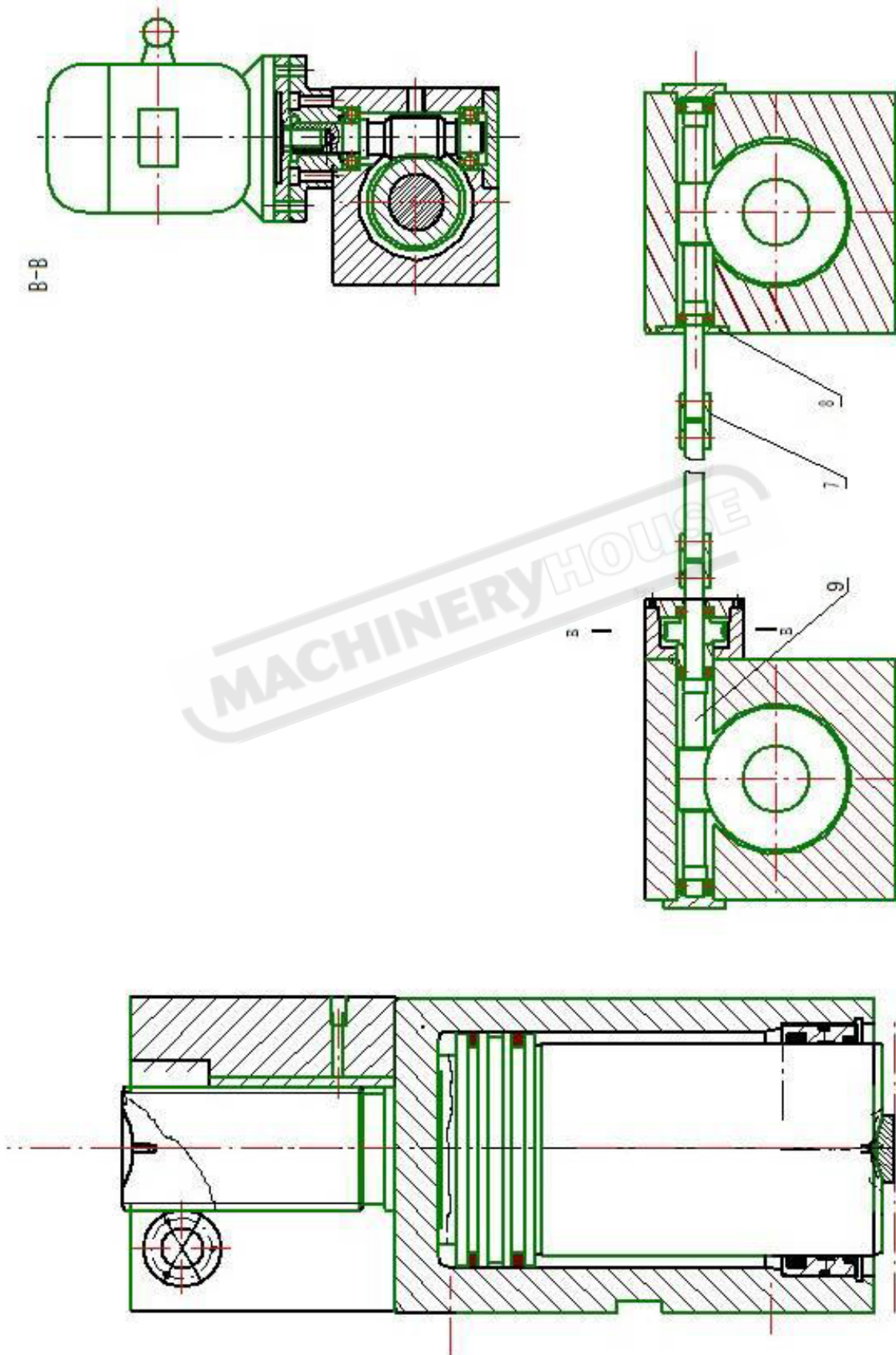

TORSION BAR SYSTEM

The mechanical torsion bar mechanism is made of seamless steel tube. It is simple in construction and convenient for maintenance. This operates a regulating technique that guarantees perfect balancing of the parallelism by making it independent of factors liable to alter it.

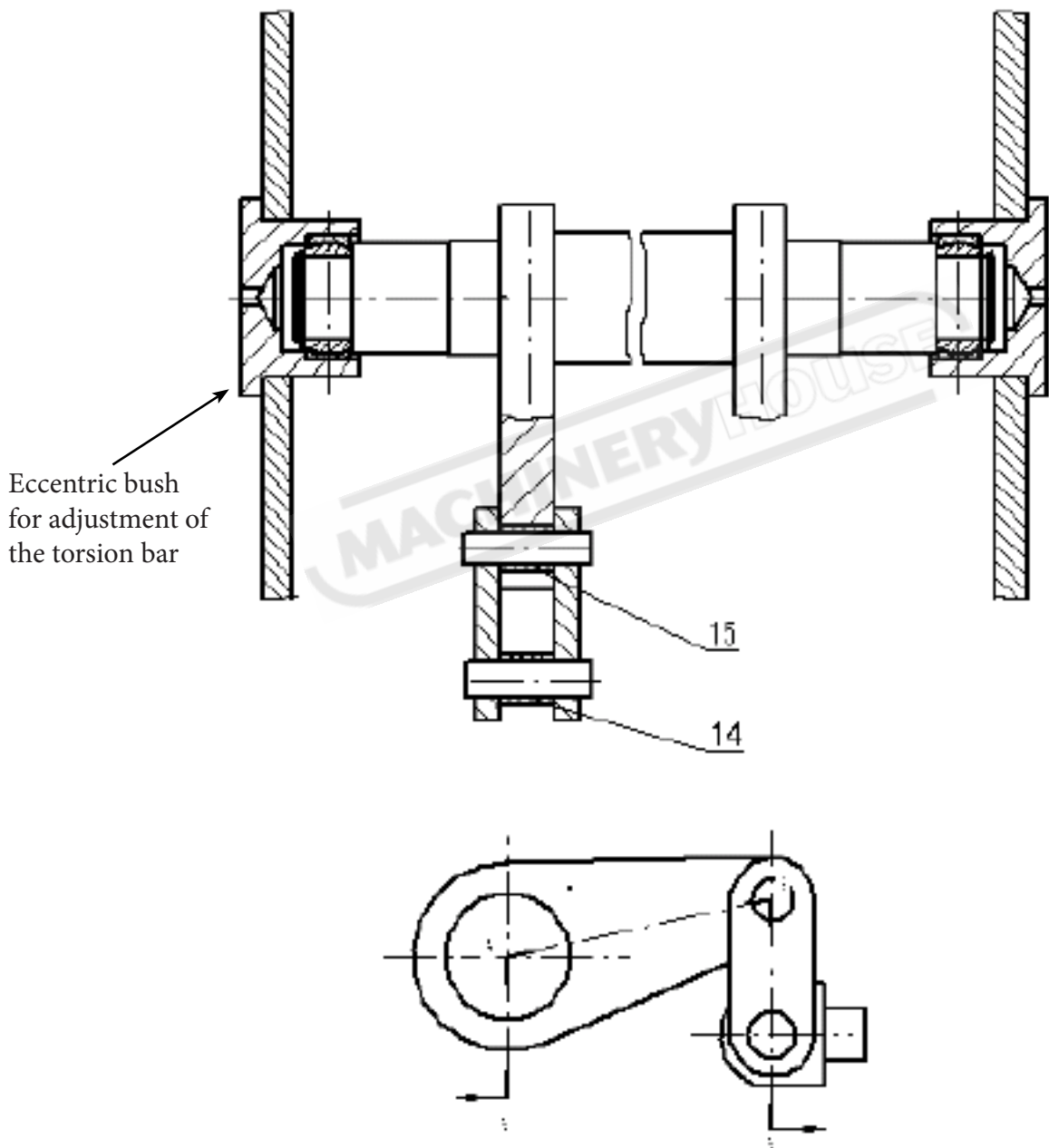

Hydraulic System

The motor, pump body, and valve board are installed between the side plates, with the oil tank mounted below the valves. The tank can be filled with oil easily.

The oil pipe line is made of seamless steel tubes. This ensures free flow of oil in any part of the hydraulic system.

Oil is filtered twice to ensure that it is kept clean and free of particles that would damage the system.

Front Sheet Supports

Steel fabricated sheet supports are designed to support a wide range of material and aligns and supports the sheet at the correct required height.

Fixed front supports Fig1

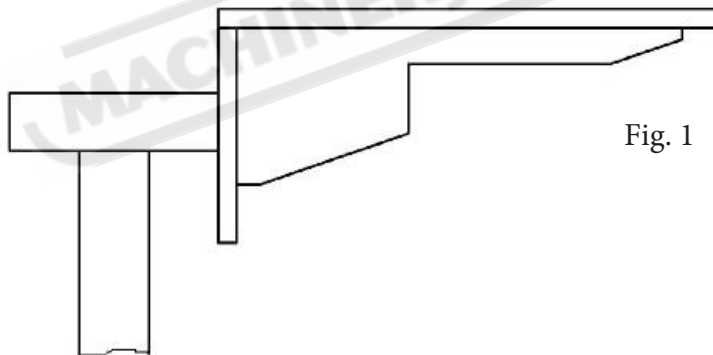

Fig. 1

Back Gauge (Fig.2)

This is controlled by the controller and driven forward and backward by an electric motor. It's movement can be indicated through a digital display with minimum readout of 0.10mm(There are two travel limiters to control the front and rear positions).The stop finger (18) can turn around the axis to prevent the workpiece from being damaged during bending.

(Fig.3)

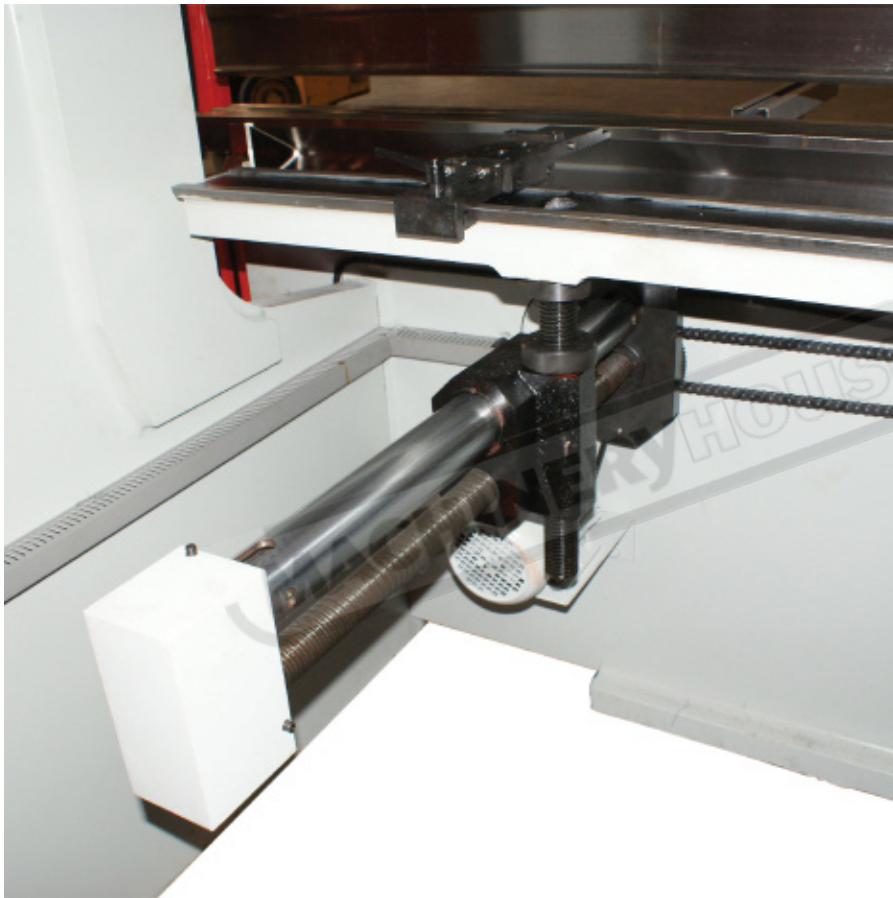

Fig. 2

Stop Finger 18
Fig.3



Dies .

The upper die is attached to the ram with a series of clamps.

Complicated bends can be obtained with the use of several upper dies, put together to form the length required.

The lower die is placed on the working table. By using the knobs(22), (23), the lower die can be moved forward and backward to align with the center of the upper die.

Hoisting circle(21), is used to lift the lower die with the ram upward stroke. When not in use it can be hung on the bolt of lower die or put in the toolbox.

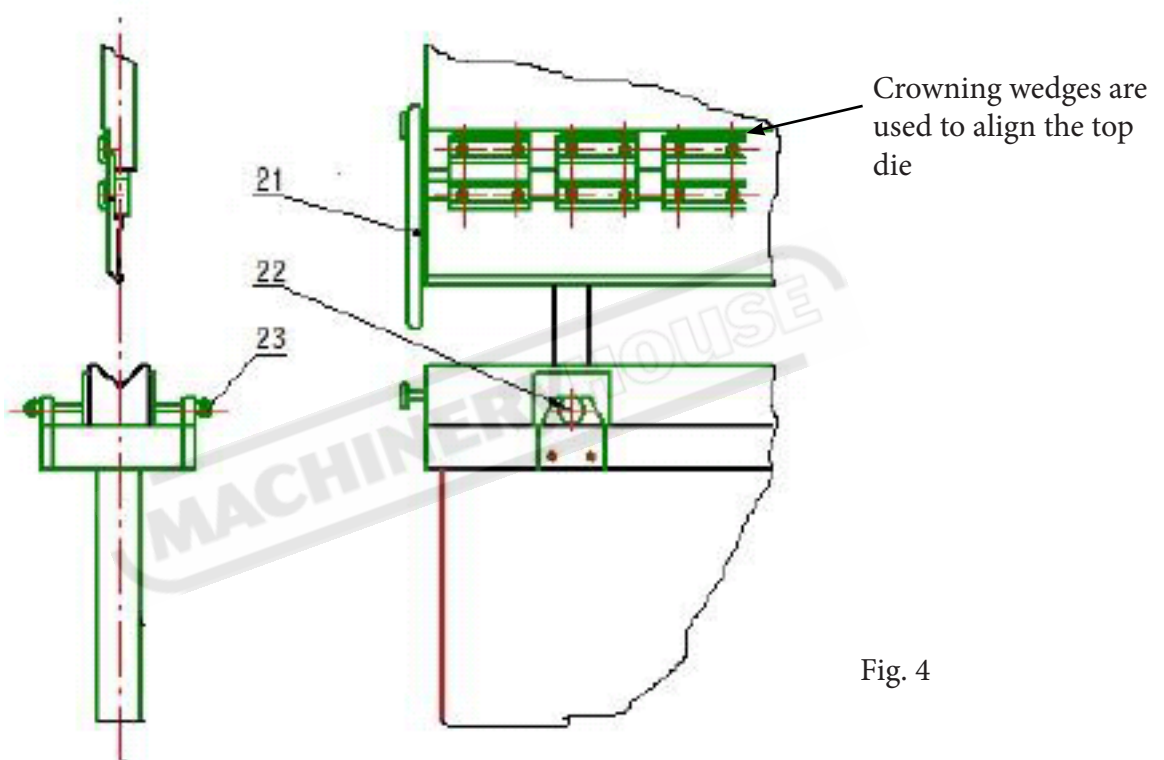

Fig. 4

Top Die Clamps

Metalmaster press brakes come supplied with standard top die clamps . (Excluding PB-220)

Optional quick action clamps are available



2.1 INSTALLATION

SELECTING THE LOCATION

The METALMASTER press brake must be installed on a rigid and stable floor such as a concrete slab 125 - 160mm thick. The press brake will be more stable if it sits on one slab and does not straddle slabs. Due to the design of the press brake bolting down to the floor is preferable.

The site must allow for access to the machine from all sides leaving enough room to cover any maintenance programs that need to be done.

The rear and front of the machine must allow for clearance of the work part

INSTALLATION

The machine needs to be leveled. The surface of the working table is accepted as the base for leveling the machine and should be leveled to a tolerance of $\leq 1000:0.30\text{mm}$, in both longitudinal and transverse plains.

If no solid foundation can be found prepare the following foundation. (Fig.2)

Install the machine on the prepared foundation, and then fix using the foundation bolts. Once attached to the bolts do the final second grouting. After the cement has solidified, check and correct the level of the machine. Bolt hole dimensions are found in table Fig.1

Foundation Table

Model	Size	A	B	C
PB-40B	40T x 2000mm	1735	1560	860
PB-70B	63T x 3200mm	2760	1800	1195
PB-135B	125T x 3200mm	2800	1850	1255
PB-135B	125T x 4000mm	3400	1850	1255
PB-170B	160T x 3200mm	2820	1840	1240
PB-170B	160T x 4000mm	3440	2200	1450
PB-200B	200T x 3200mm	2840	2200	1550
PB-200B	200T x 4000mm	3440	2200	1550

Fig.1

Foundation Diagram

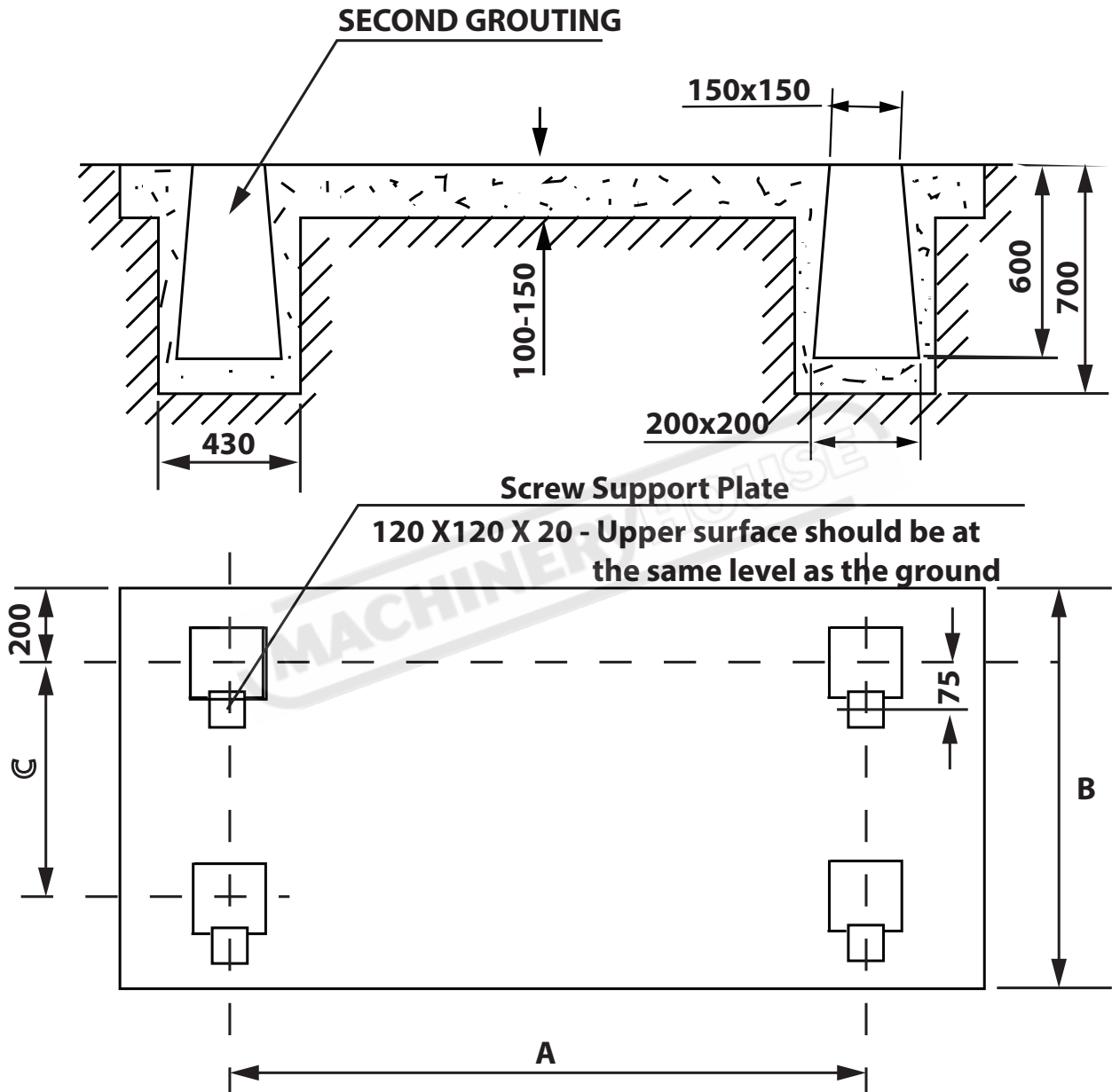

Fig.2

LIFTING

On the day that the machine arrives, make sure that a crane with sufficient capacity is available to unload the press brake from the vehicle. Ensure access to the chosen site is clear and that doors and ceilings are sufficiently high and wide enough to receive the machine.

To handle the press brake, use only the two sling holes located on the top of the end plates.

These must only be used as the center of gravity of the machine is higher than expected, and the rear-section at the top of the machine is not evenly balanced in weight. The center of gravity should be properly positioned to prevent the machine from toppling over.

Metalmaster recommend that you use a spreader lifting beam when lifting the machine.

If you have to use slings please take note of the sling angle and the loads that apply

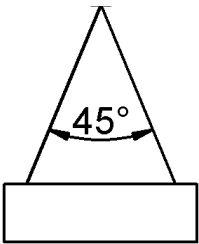

When the slings are at a 45° angle then each sling will carry the equivalent of 50% of load weight.

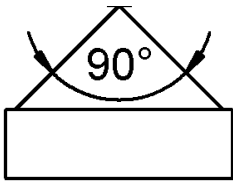

When the slings are at a 90° angle then each sling will carry the equivalent of 75% of the load weight on each sling.

Note! Metalmaster recommend not to exceed 90° angle

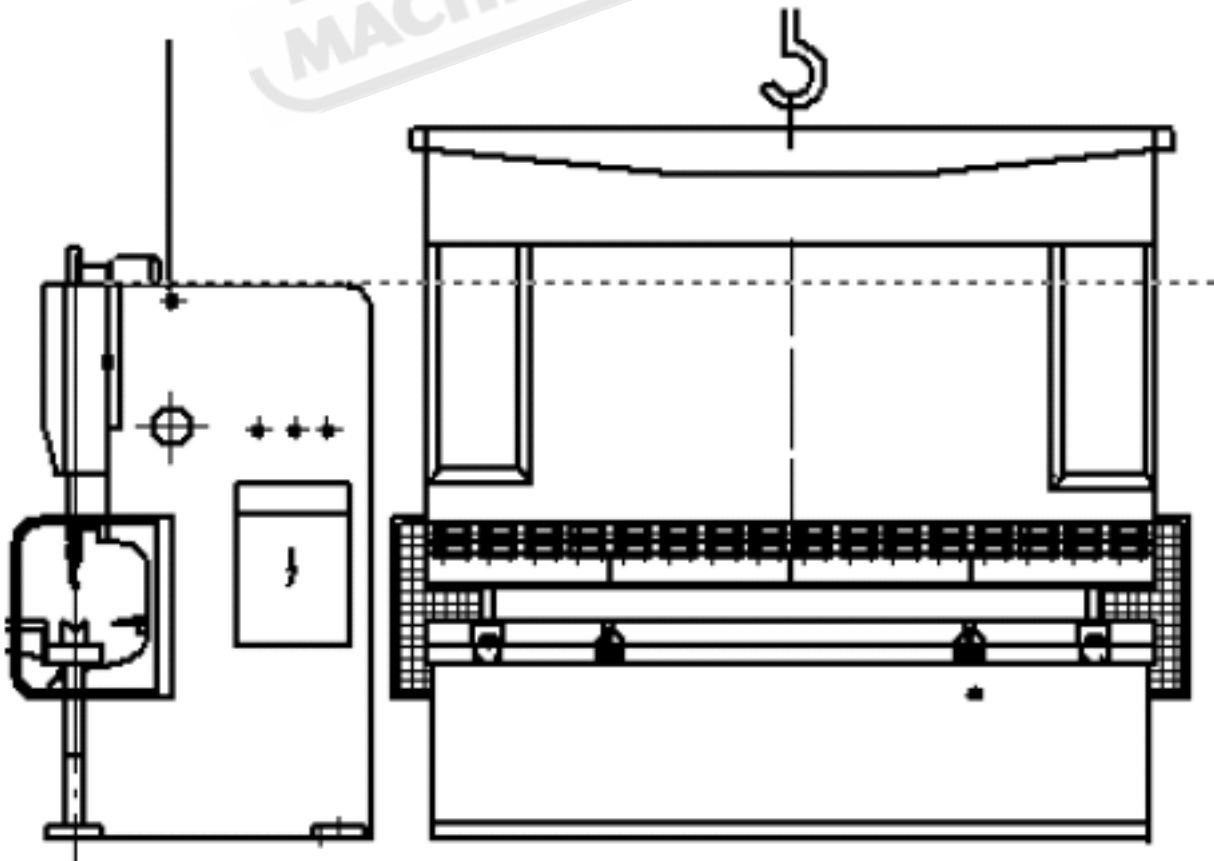

2.2. SAFETY PRECAUTIONS

BASIC POINTS

Apply all necessary safety measures, during the machine installation, operation, and when maintenance is required. Attention to the safety precautions needs to be taken when attempting the following

- Do not service or adjust the machine until you have read the manual.
- All electrical work must be performed by a qualified electrician, to avoid equipment damage. Failure to do so may cause physical injury.
- Under no circumstances place your hands between tools.
- Do not enter inside the safety device covered area nor in the hazardous zone.
- Do not modify any part of the machine, or the control circuits
- Never use the machine with any of its safety devices disabled or removed.
- Inspect daily the machine before starting work to ensure that :
 - All safety devices are working.
 - There is no obstruction in between the tools.
 - There is a clear access to the control panels.
 - The floor around the machine is free of grease, oil, and water.
- Wear the appropriate clothing when adjusting or operating a press brake. Do not wear loose clothing.
- Make it standard practice that a single qualified, trained operator performs machine adjustments. If working on large parts, the operator should be helped by an assistant operator whose sole task is to help handle the part.
- Before any machine inspection or maintenance, the main electrical isolating switch should be switch off unless power is required for the procedure concerned. In such cases, only personnel with the appropriate training are authorized to carry out the procedure.
- Wear protective gloves whenever possible.
- On the rare occasions when the user bends parts whose overall size exceeds the length of the bottom die, protective measures must be put in place to prevent injury to other workers. If this type of work is performed regularly, additional protective measures must be permanently installed, and hard wired into the machine's control circuit.

SAFETY SYMBOLS

Fixed to the front of the press brake are safety symbols designed to make sure the machine is safely operated



Hearing and eye protection are extremely important as the result of an injury to these parts of the body may cause permanent damage. Safety glasses and hearing protection must be approved



When operating the press-bake hands and arms must at all times be kept from between the top and bottom die. Failure to do so may cause severe crushing.



With all hydraulic press brakes it is important that pressing takes place between the two rams in the center of the beam. This insures equal pressure is applied to both rams.



Never attempt to support the end of the workpiece by holding it on either side of the tools. No part of your body must enter the hazardous area during bending operations. Beware of sudden movements of the worksheet during bending



Never hold the sheet by its folded edge; hold it from the sides

Protective Equipments for Personal

Personal Protective Equipment are not included with the Metamaster machine.

Listed below are examples of the type of Protective Equipment that the operator will require when using this machine

- gloves,
- helmets,
- ear guards,
- goggles,
- goggles to protect against laser radiations,
- safety shoes,
- etc.

It is the responsibility of the operator and supervisor to ensure that the equipment he /she is using fully complies with the Australian & New Zealand Health and Safety Acts.

It is the responsibility of the employer to ensure that

- the appropriate safety equipment selected relates to the risks involved,
- the appropriate safety equipment meets the employee concerned,
- that the employee is using the safety equipment correctly,
- the safety equipment complies with the relevant regulation,
- people who are responsible for the implementation have been informed
- that the safety equipment is in perfect working condition and periodic checking takes place,
- users have been trained in the use of the safety equipment and encourage users in the regular use of the safety equipment.

All safety equipment being used should be marked with the following

- name or the trade mark of the manufacturer,
- identified either by commercial name or the reference
- the size, if implies,
- the expiry date, if implies,

If applicable the safety equipment should be accompanied by the information leaflet and user manual with a declaration stating that it complies fully with the relevant standard



2.3 COMMISSIONING

The METALMASTER Press brake is supplied on a metal shipping frame which needs to be removed before the machine is placed on the floor. Safety first must be observed to insure that the removal of the frame is done in a manner that will not injure the workers or cause damage to the machine.



Fig.1

Mounted in the back of the machine is a toolbox (Fig.1) which is attached to the machine and needs to be removed before the machine can be setup ready for use.

The toolbox is held by a RHS straps which may need the welding to be ground away to remove the toolbox.

CLEANING

Thoroughly clean protective grease from all other parts of the machine. Remove the grease with a rag saturated in a cleaning solvent (mineral spirits) and wipe with clean rags. A stiff brush will get into the corners. Do not use an air hose as the pressure could drive grit and dirt into bearing surfaces. After cleaning the machine thoroughly wipe dry. Make sure no dirt or grit is left, lightly oil the bed and ram finished surfaces. Periodic cleaning of the machine after installation is recommended.

Never use abrasive products or solvents that are liable to damage the machine surfaces.

INSTALLING THE CONTROL DEVICES

Insure that the backgauge is in place and free to operate. Remove any transport stops and clamps. Attach the foot-switch which is supplied ready for connection.

MACHINE LEVELING

To set your machine up so that it operates to optimum performance, apply the following procedure Your press is designed to be anchored to a concrete slab floor, which should be at least 125-160mm thick The leveling is performed using each of the screws on each pad.(Fig. 2). A level is to be placed on the surface of the working table or bottom die. Tolerances: 1000:0.30mm, for both longitudinal and transverse. Metal plates need to be placed under each jacking screw to distribute the load.

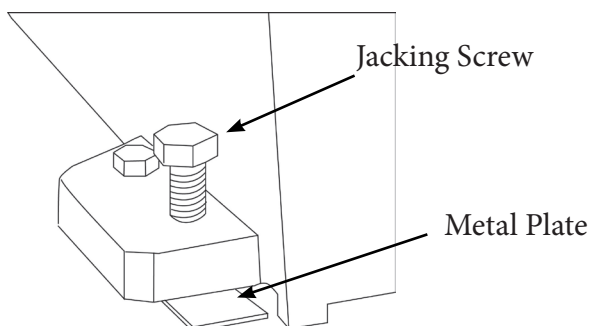

Fig.2



The machine must not rest on supports other than those defined in Fig.2

2.4. ELECTRICAL CONNECTIONS

The correct operation of an electrical system depends on the quality of its power supply ; it must be stable and free of interference.

- Power supply: Three-phase 415volt 50Hz

Checking The Power Supply

The machine must be connected to the power by a qualified and licensed electrician. Warranty will be voided if it is found that the connection was not carried out by a qualified electrician.

Check the Pump Rotation

Check the direction of rotation of the motor. The fan blades on the end of the motor need to rotate clockwise

- If the direction does not match, stop the pump and change the rotation by swapping the phases.



2.5 CONTROLS

Before operating the machine it is essential that you know where the controls are and what they do. The isolating switch is mounted on the front of the electrical box on the side of the machine. The operating controls are mounted on the pendant. The bottom half of the pendant has the following controls.

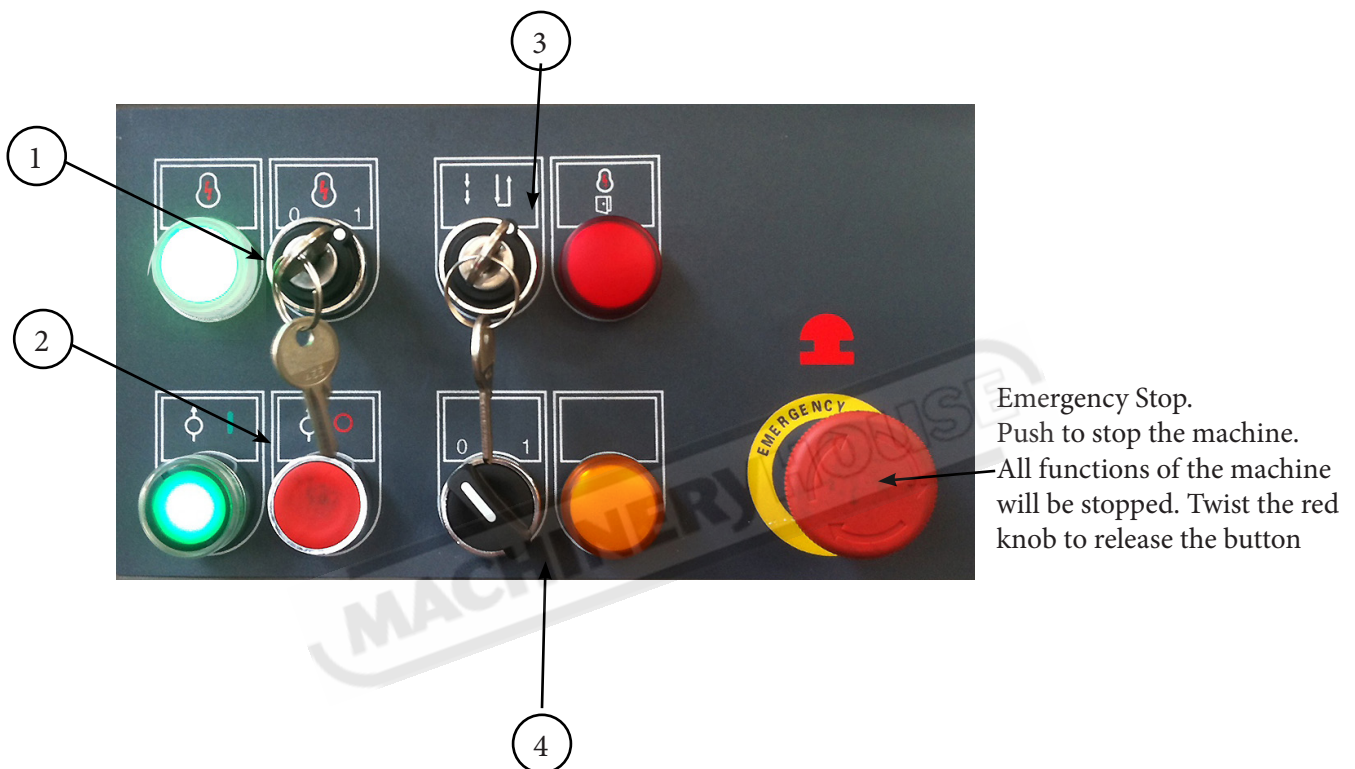

- 1 This switch will turn on the power to the E21 controller. The white light will be on when power is on.

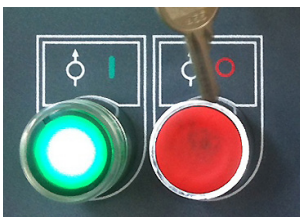

- 2 This button is the on/off button for the hydraulic pump. The green light will be on when the pump is running.

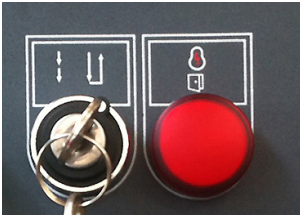

3

Inching/Jog

This switch controls the type of travel of the beam. When the switch is in the left position the controller will move the beam up or down with the pedals or buttons. Once the pedal is released the beam will stop. This way the beam can be inched up and down. Continue to hold down the down pedal and the beam will travel down until it hits the limit stop. To raise the beam the up foot pedal is pressed to return the beam to top position. In this mode the foot pedals control the movement of the beam both in the up and down travel.

Switch/Single

When the switch is in the right position, press the down foot pedal and the beam will travel down continuously until it presses and times out. Leaving the foot on the down pedal and it will automatically return it to the top position. If you brake the light curtain when the beam is traveling down fast the beam will stop even though the down pedal is still pressed. Release the pedal and press down again to travel down at a slow speed or press the up pedal to return to top of stroke.

Red Light

The red light will illuminate when the back gate is open or one of the emergency stop buttons is depressed and has not been reset.

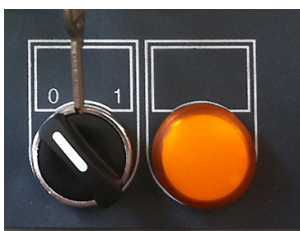

4

This switch is only used when some light guard systems are used. When fitted with a light guard the switch will control the ON/OFF of the blanking to allow the material rests to be fitted. The orange light will display when the mute point is reached.

Mute Light

If the light curtain is broken and the foot pedal is pressed the beam will travel down slowly and the mute light will be on. Mute means the guarding system will no longer recognise an obstruction. If you break the beam with the work piece or a body part the top beam will continue to move down at a slow speed.

Note: If a Foldsafe guarding system is fitted this switch and indicator light will not be used, these functions are on the Foldsafe touch panel.

Mobile Control Foot Pedals



Mute Lamp



Blanking ON/OFF
(same key as "2")

2.6.LIGHT CURTAINS

Light curtains are a compulsory safety component fitted to the press brake as a production friendly safety measure. They are designed so that they do not physically impact on the actions being carried out by the machine operator. Safety curtain protection protects the operators when the workpiece is to be passed in and out of a risk area.

How does a light curtain work?

Light curtains utilize an optical transmitter and a receiver unit. From the transmitter, beams of infrared light are sent to the receiver. When the light beam is interrupted, a stop signal is sent to the machine and protects the operators if they move into the light curtain protected area. (Fig.1)

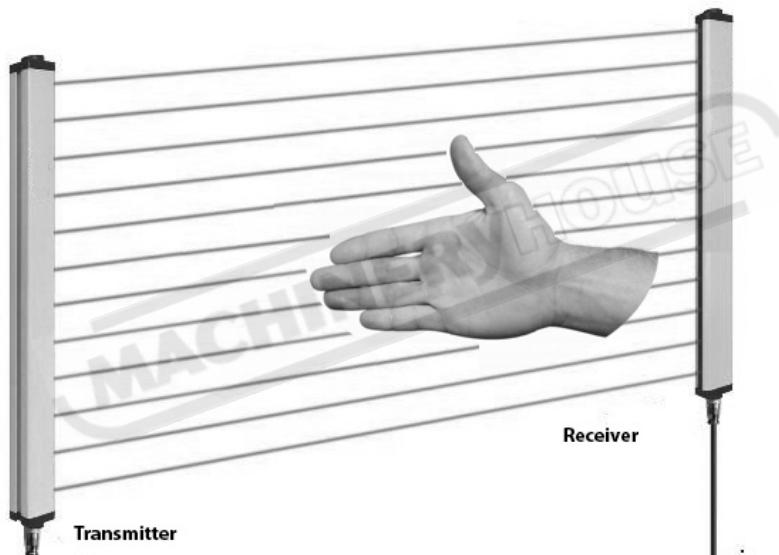

Fig.1

To show that there has been an interruption to one of the light beams, the mute lamp will be illuminated and the machine will stop. The top beam of the machine can now only be moved down at a reduced speed by releasing and repressing the down foot pedal.



Light curtains must never be disabled.
Machines **MUST NOT** be used if the light curtain
is faulty.

Setting the Mute Point

The mute point must be set so the top die is no more than 4-6mm above the material surface, preventing entry of fingers into the danger zone. The light curtain is disabled when the top die passes the mute point on the way down to allow the bend to be made. The mute point must be set so that fingers are not able to enter between the dies. (Fig.2)

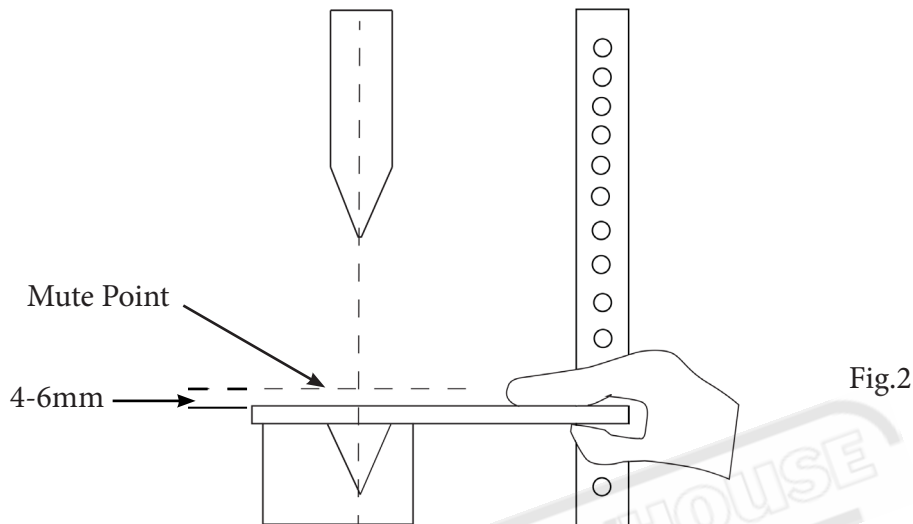

Operating with Light Curtain

When operating in any mode, and the light curtain has not been interrupted, the blade will travel down at the fast speed until it has reached the “ Mute Point” and from there it will change speed and travel slowly down into die block until it has come to bottom limit and then return to natural top position traveling back at the fast speed.

When operating and the light curtain has been interrupted, the mute light will be illuminated. It will stop the upper blade from moving down. When either the foot pedal or finger button is repressed it will continue moving down, but at a slow speed until it has comes to bottom limit and then it will return to the natural top position, moving up at the faster speed.

If before operating the press brake, the light curtain has been interrupted, by either the side doors being open, or the operator standing in front of the machine holding a work piece, the blade will still move down, but will travel slowly until it comes to the lower limit, and then return at the faster speed to its top limit.

When the back door is open, the press brake will shut-down completely. No functions will be available until the door is closed. The warning light would be on until the door is closed. (Item 3 Page 25)

For blanking details with Foldfast light curtains consult the Foldfast manual at the end of this manual
Details of the detection range and capacity are displayed on the light curtain

2.7. TRIAL RUN AND OPERATION

Before trial run, all lubricating points should be lubricated with grease. At the same time fill the tank with No.30 hydraulic oil. (The oil should be change one month later for the first time, and then do the replacement every year according to conditions. The lowest temperature should be kept above 10 degrees)

1. Check the Safety System

Before operating the machine the safety warning system should be checked to insure they are working correctly. This can be done by interrupting the light curtain and checking if the mute lamp is illuminated (item 3 Page 24). Open the back door and check if the warning light is illuminated (Item3 Page 24). Check also the operation of the light curtain by placing material 30mm thick at the bottom die. The beam should stop and the light curtain warning light should be illuminated. If it is found to be faulty contact your dealer.

2. Check the Operation.

During the first trial run, it is advisable to operate the machine with “jog mode”.

Once you are satisfied that all is working OK, then “single mode” can be tried. At this time the ram travel, the control of back gauge and the function of the solenoid relief valve can be tested.

When the machine is operating correctly, the following operation can be carried out according to the procedure below.

- (1) Calculate or check the bending pressure and the opening width of the lower die.
- (2) Align the centers of upper and lower dies.
- (3) Set the ram travel.
- (4) Determine the positions of the sheet supports and the back gauge.
- (5) Determine the positions of upper and lower stops.
- (6) Determine the operation mode of “jog”, or “single”
- (7) Place the workpiece in the middle of the working table and make a bending trial.

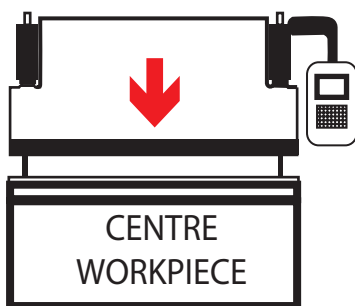

Notice:

(1)The machine is suitable only for bending in the center of the machine. Bending on one end of the machine may damage the accuracy of the machine. In the case where there is need for a single-sided bend, it is advised to compensate by bending on both sides simultaneous in order to even the load.

(2)Before bending consult the bending chart to insure that the pressure is not exceeded.

3.1. BENDING TECHNIQUES

There are two basic bending techniques:

- AIR BENDING

This method is commonly performed because relatively low bending forces are required

- COINING

This method requires forces approximately three to five times those of air bending. It allows the inside radius to be coined. This method almost eliminates the elasticity of the material.

AIR BENDING

During air bending, the sheet metal retains certain amount of elasticity. An acute angle, higher than the desired angle, is generally bent to compensate for the spring back effect. The bending chart (Fig.3) located on the side of the press brake shows the required force and internal radius which can be achieved along with the other characteristics such as the thickness of the material and the die opening,

During air bending, the sheet is in contact with the tools at three points (A, B, C) as shown in the diagram Fig.1

To obtain a quality bend using air bending, it is necessary that the die opening is between 6-12 times the sheet thickness. In this way, sheet angle is reached before it touches the bottom of the die. Consult the bending chart for

1. What size die to use,
2. What the minimum return size can be for the die being use
3. What radius will be achieved
4. What tonnage it will take to bend the material per meter.

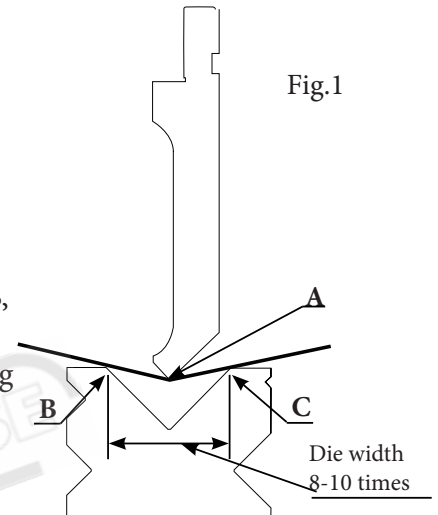

COINING

This type of bending is where the end of the punch presses the sheet to the bottom of the die, rupturing the elasticity of the sheet. This then causes the sheet to be bent exactly to the shape of the punch.

Note! This requires special tooling to be purchased and standard tooling can not be used. When buying this type of tooling please insure that they supply you with the correct bending chart to suit the tooling.

The forces at the end of bending are 3 to 5 times the air bending forces, which causes the coining of the sheet.

NOTE

The choice of the top die radius is very important for coining, because it determines the inside radius of the bend in the sheet.

Coining can only be performed with a punch and die of the same angular value.

Very high bending forces must be applied. These may reach values from 3 to 5 times those shown on the air bending chart.

CAUTION: Because coining involves very high forces, take great care to check the strength of the tools being used. Never exceed the applicable force limits.

Contact you tool supplier if unable to find the values.

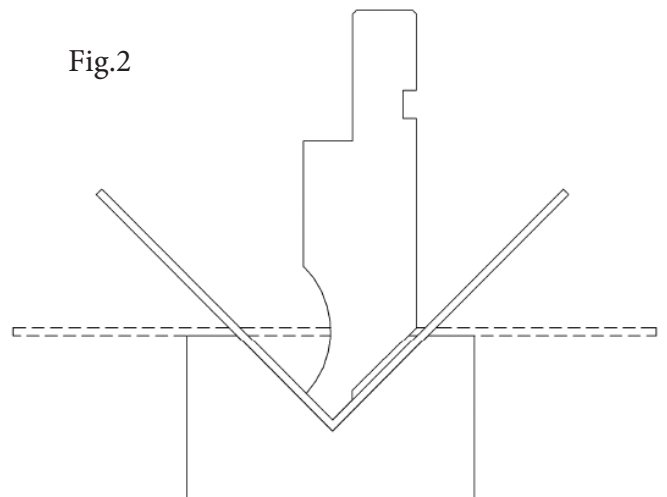

Bending Chart

Fig.3

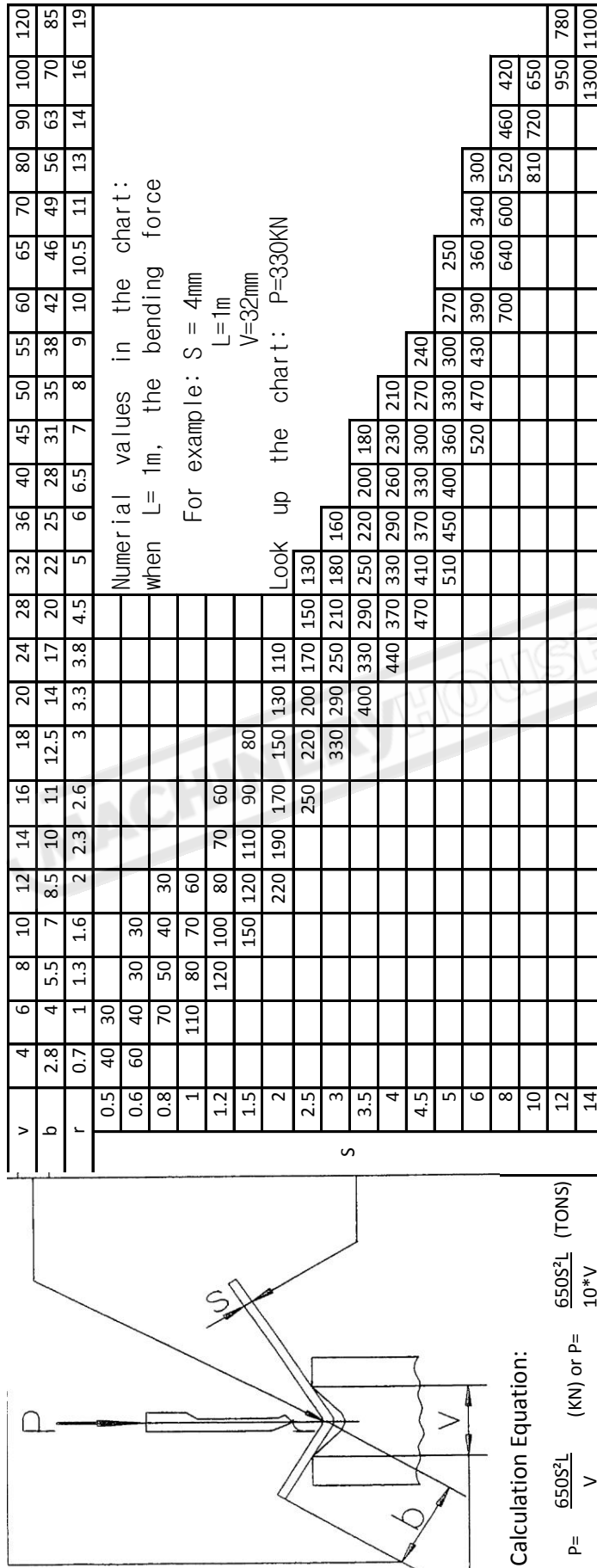

Notes: This calculation formula and numerical values in the chart are based on the calculation of the material with a tensile strength of $\approx 450MPa$.
When bending other materials with different tensile strength force can be calculated in proportion to the material's tensile strength.
When working regularly, select the pressure according to the thickness and the length of the plate to be bent. Adjust the pressure below 10Mpa when you want to adjust the height between the die and the ram.

3.2 ADJUSTMENT OF LOWER & UPPER LIMIT OF THE RAM

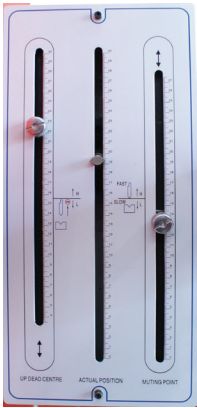

↑ A ↑ B ↑ C

It is important that production time in considered when bending occurs. For this reason free travel time needs to set to a minimum. Since plates to be bent vary in thickness and the Vee-groove opening of the lower die vary in size, the travel distance of the ram needs to be adjusted accordingly. On the front of the machine (Fig.4) are the ram limit stops for the travel of the rams.

1. Adjustment of upper-limit of the ram

While the ram is traveling upwards, the stop “A” (see Fig.4) will touches the limit switch. This causes the ram to stop at the position. This will reduce the no-load travel distance of the ram and raise productivity.

Note! This needs to set high enough so that the work piece can easily be removed after bending.

The center slot (B) is the visual display of the actual position of the ram (see Fig.4) and does not require an y adjustment.

Setting the Mute Point of the Ram.

While the ram is traveling downwards, the stop “C”(see Fig.4) touches the limit switch. This is known as the mute position of the ram. This is the point at which the travel speed of the ram is changed from a rapid approach to a more controllible slower speed during bending. The ideal setting is when the top die is 4 - 6mm above the sheet thickness.

NOTE! When tooling is changed the mute point must be changed to suit tooling and material thickness.

Adjusting the Bend Angle of the Workpiece

During the working process of the ram and the working table, inconsistencies can occur. Sometimes the angle in the center of the bent workpiece becomes larger than the angle on both ends. This usually only happens when pushing the press brake to more than 30% of its capacity.

There are two ways to fix this problem.

The easiest fix is to shim up the middle of the bottom die or adjust the crowning table if fitted

The top die can also be adjusted. To do this lightly loosen the top die bolts making sure that it does not drop. Once loosened, lightly hammer the wedge “D” (see Fig.5) into the upper die pad, to make the central part of the upper die crown. Tighten and try bending again until the bend angle of the workpiece is the same degree along the length of the workpiece.

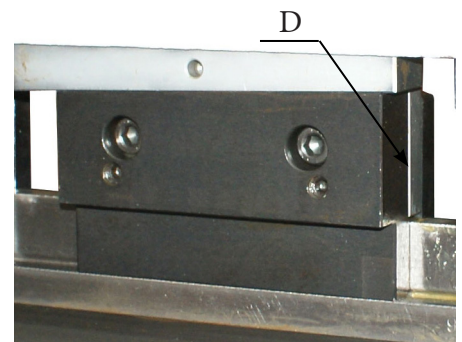

Fig. 5

6.Adjustment of the Bending Pressure

The correct bending pressure is found by checking the bending pressure chart or from by using the calculating formula. General rule of thumb the bending pressure should be set at 18-20mpa. If the pressure needs to be changed, adjust the relief valve to increase the pressure higher than the bending pressure, so that unnecessary load can be reduced.

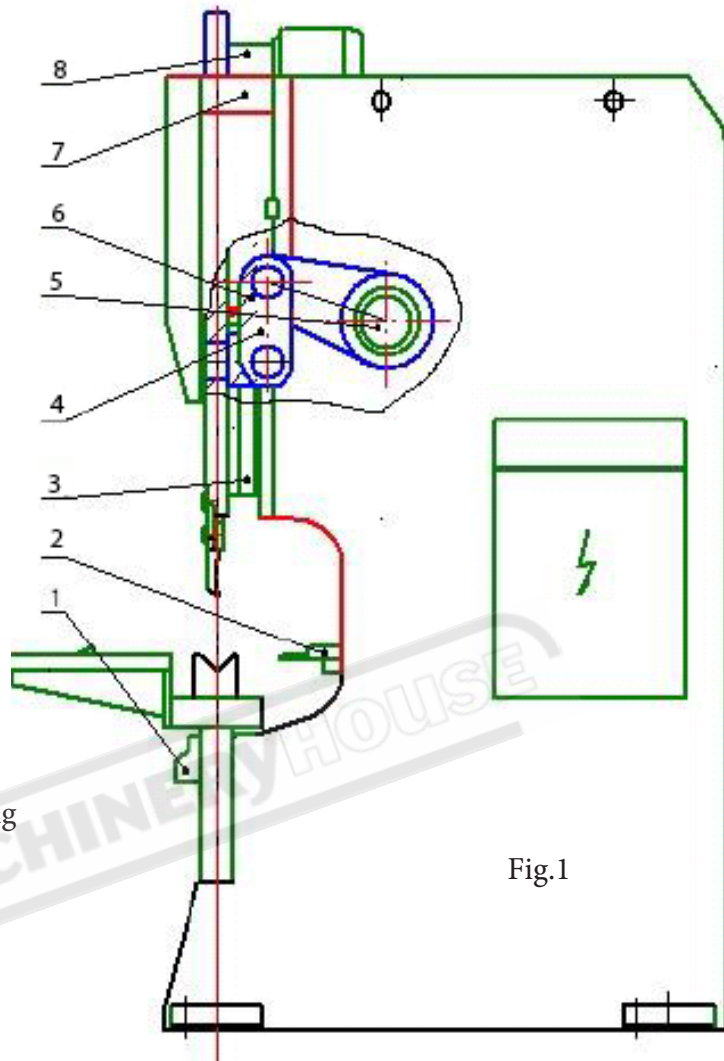

Fig. 6

4.1. LUBRICATION SCHEDULE

METALMASTER Press brake have individual lubrication points. The lubrication scheduled should be carried out according to working conditions and in accordance with the table below. Oil or grease is applied to the points described on Fig.1

Grease is provided in the upper worm gear of the oil cylinder. Replenishment or replacement is carried out according of working conditions.



Schematic diagram of lubricating points

Fig.1

No.	Name of lubricating point	Oil site count	Oiling time	Brand of lubricant
1	Digital indicator(back gauge)	2	48hours	Machine oil 46#
2	Slide (back gauge)	4	48 hours	Calcium base grease ZG-3
3	Guide way	2	4 hours	Calcium base grease ZG-3
4	Ram props	2	4 hours	Calcium base grease ZG-3
5	Torsion-bar bearing	2	8 hours	Calcium base grease ZG-3
6	Connecting rod(right & left)	2	4 hours	Calcium base grease ZG-3
7	Worm gear box	1	500 hours	Calcium base grease ZG-3
8	Digital indicator(up fine adjustment)	2	48 hours	Machine oil 46#

4.2 HYDRAULIC SYSTEM OF THE MACHINE

The hydraulic system working principles are displayed in Fig.1.

INACTIVE: When the oil pump is running, the oil feeds out, through an oil pipe and into the valve plate and solenoid valve, then returns into the oil tank. At this time the solenoid valve isn't working, The No.12 valve is closed and the top beam is stationary .

DOWN FAST: When the down button is pressed, valves YV1, YV2, YV4 operate. The pressurized oil enters into the top of the cylinders through valve No.10, and at the same time, because of the throttle valve effect, the pressure of the oil rises. This makes valve No12, and No. 15 open under pressure,. The beam moves down fast.

The pressurised oil in the lower cavity of cylinder returns the oil to the oil tank through valves No.12, No.7 and N0.10. The cylinders top cavity forms a vacuum and fills the oil by valve No.15,

DOWN SLOW When the down switch is pressed, the SQ6,solenoid valve and YA1,YA4,YA5 are activated and the single valve No.15 is closed. A small apiture inside the system restricts the oil flow. The top beam enters work-speed,

UP FAST: When the up button is pressed the beam rises. The solenoid valve YV1 powers off Then YV1, YV3 valves power on, and with the effect of the throttle valve, the pressurized oil enters into the cylinder's lower cavity from valve No.10 and No.12. The beam returns, and the pressurized oil in cylinder's top cavity returns to oil tank by valve No.15.

The foots-switch controls the top beam movement for inching work. The valve No.5 and No.16 adjust the working pressure of system.

The overflow valve No.13 adjusts the return pressure. The pressure should be controlled within 12Mpa.

VALVE LOGIC TABLE

	YV1	YV2	YV3	YV4	YV5
INACTIVE	-	-	-	-	-
DOWNWARD FAST	+	+	-	+	-
DOWNWARD SLOW	+	-	-	+	+
PRESSURE	+	-	-	+	+
UPWARD	+	-	+	-	-
DECOMPRESSED	-	-	-	+	+

Hydraulic Diagram

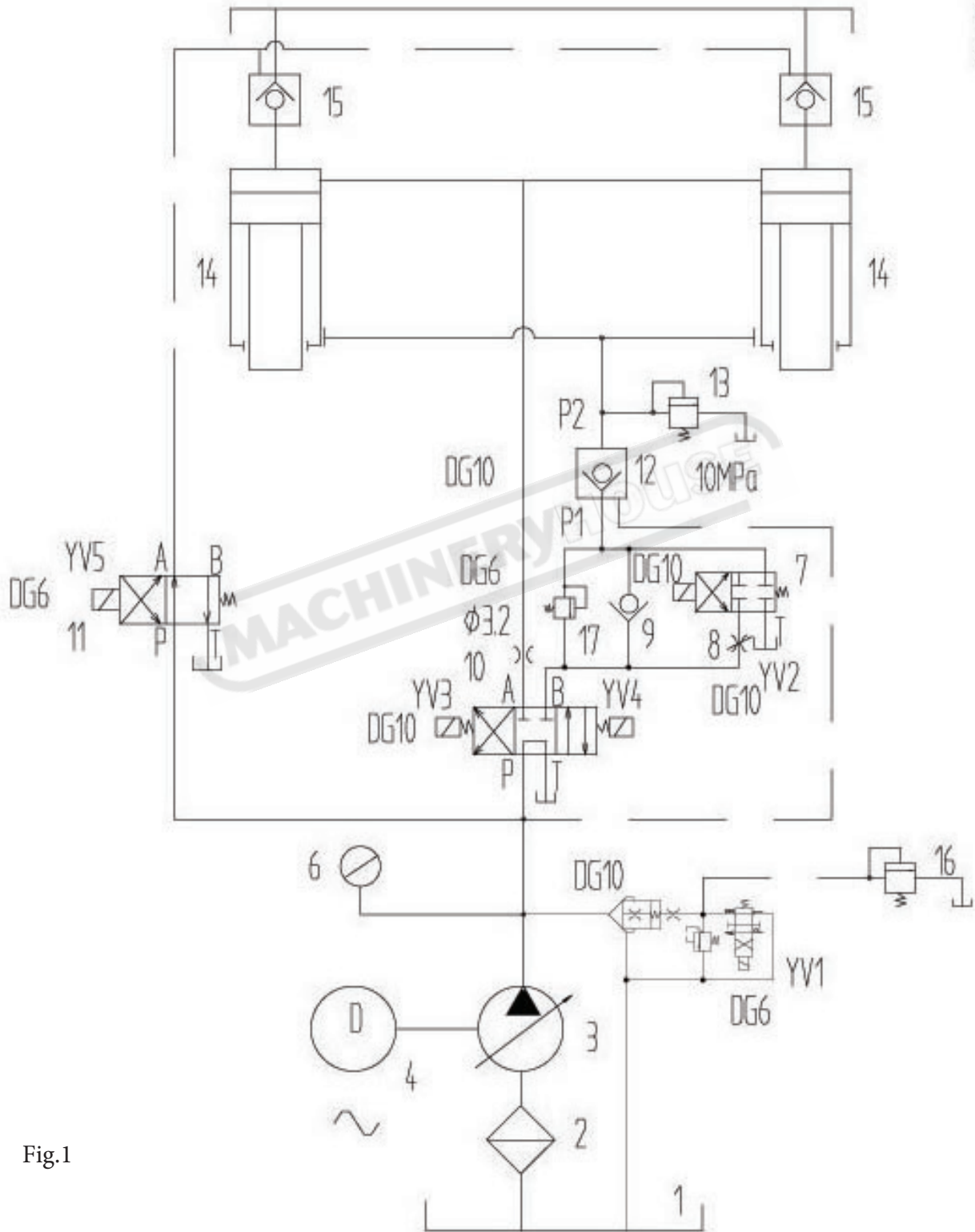
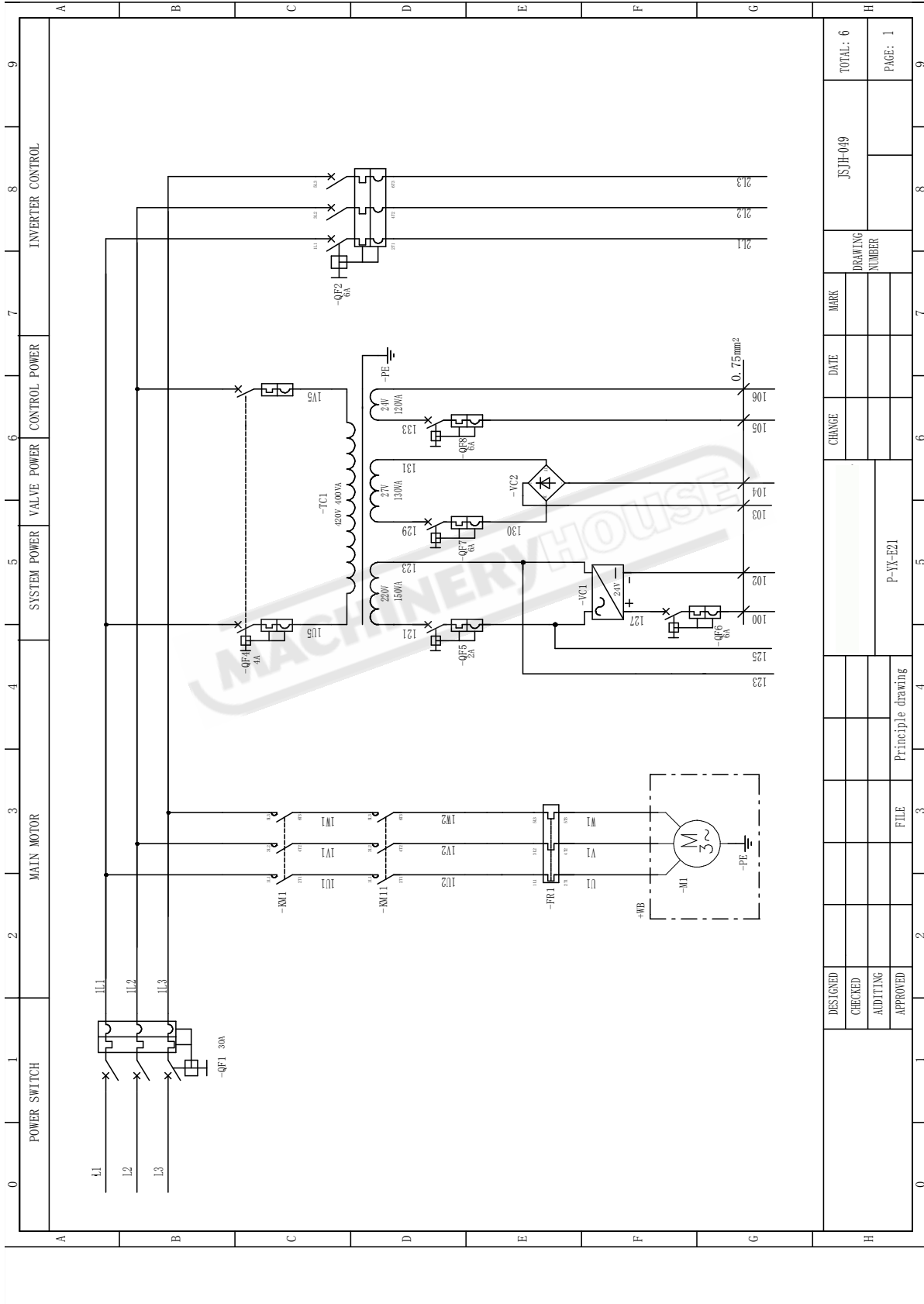

Fig.1

Hydraulic Component List

No.	Name	Type	Specification	Qty.	Remark
1	Oil tank			1	
2	Mesh filter			1	
3	Gear pump			1	
4	Motor		P=7.5kW n=960Mpa	1	
5	Solenoid overflow valve	DG10	D=10 P=31.5MPa	1	
6	Manometer	YN60-m(ZT)	P=40MPa	1	
7	Solenoid reverse valve	4WE10EA50/AG24NZ4	d=10 F=31.5MPa	1	
8	Throttle valve	DGMFN-3-Z-P2W-21	d=10 F=31.5MPa	1	
9	Valve	TCVD-XCN	d=10 F=31.5MPa	1	
10	Solenoid reverse valve	4WE10G50/AG24NZ4	d=10 F=31.5MPa	1	
11	Solenoid reverse valve	4WE6D50/AG24NZ4	d=10 F=31.5MPa	1	
12	Hydraulic control check valve	SV10PA1-30	d=10 F=31.5MPa	1	
13	Distant compressor valve	YF-B8H3	d=10 F=31.5MPa	1	
14	Oil cylinder			2	
15	Hydraulic control check valve			2	
16	Distant compressor valve	YF-L8H4-S	d=3	1	
17	Translation overflow valve	CPG-00		1	
18					
19					
20					

Electrical Diagrams



DESTONED		TOTAL: 6	
CHECKED	JSJH-049	DRAWING NUMBER	
AUDITING		PAGE: 1	
APPROVED	P-YX-E21	MARK	
	Principle drawing	DATE	
	FILE	6	
		7	
		8	
		9	

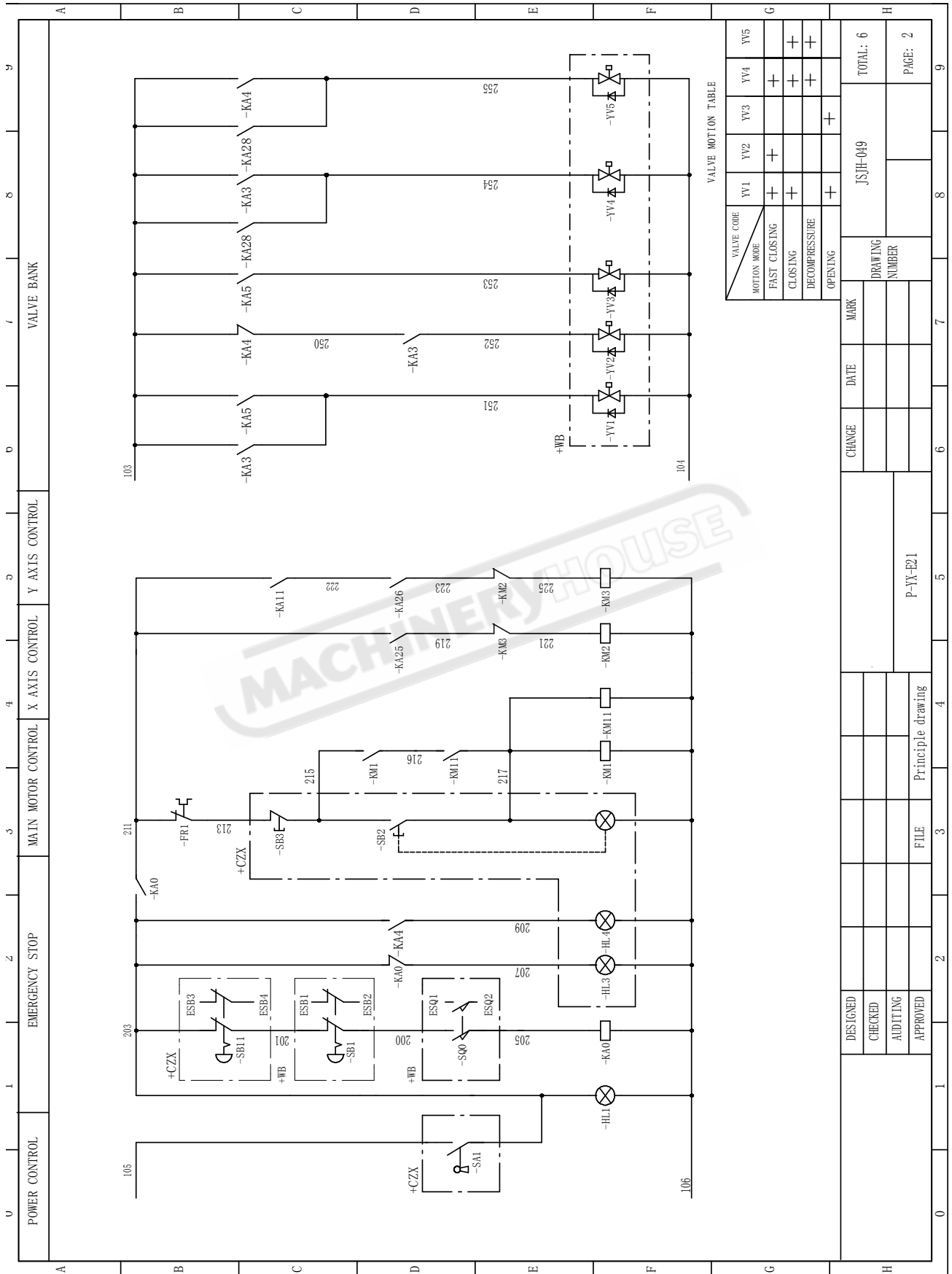

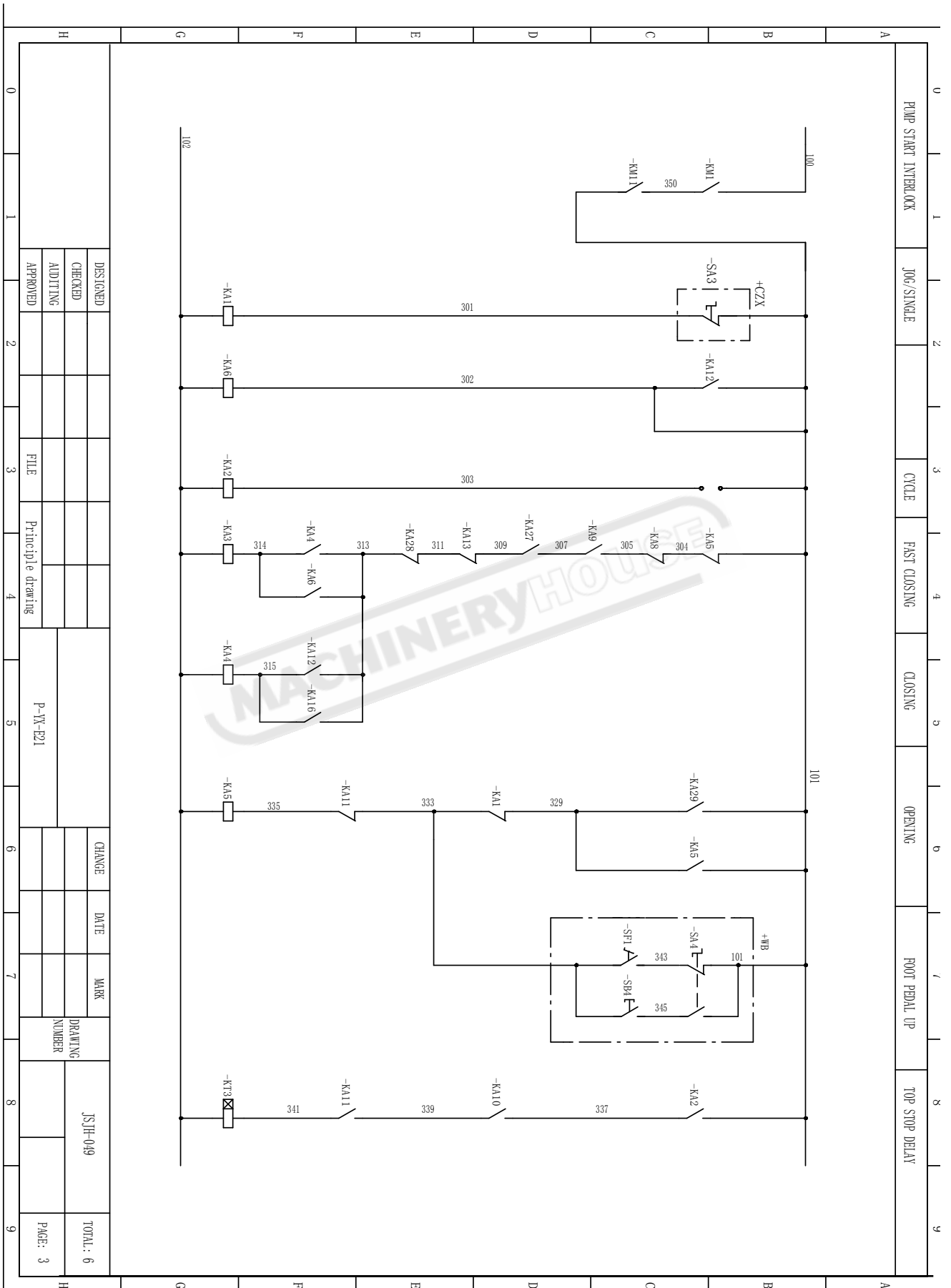

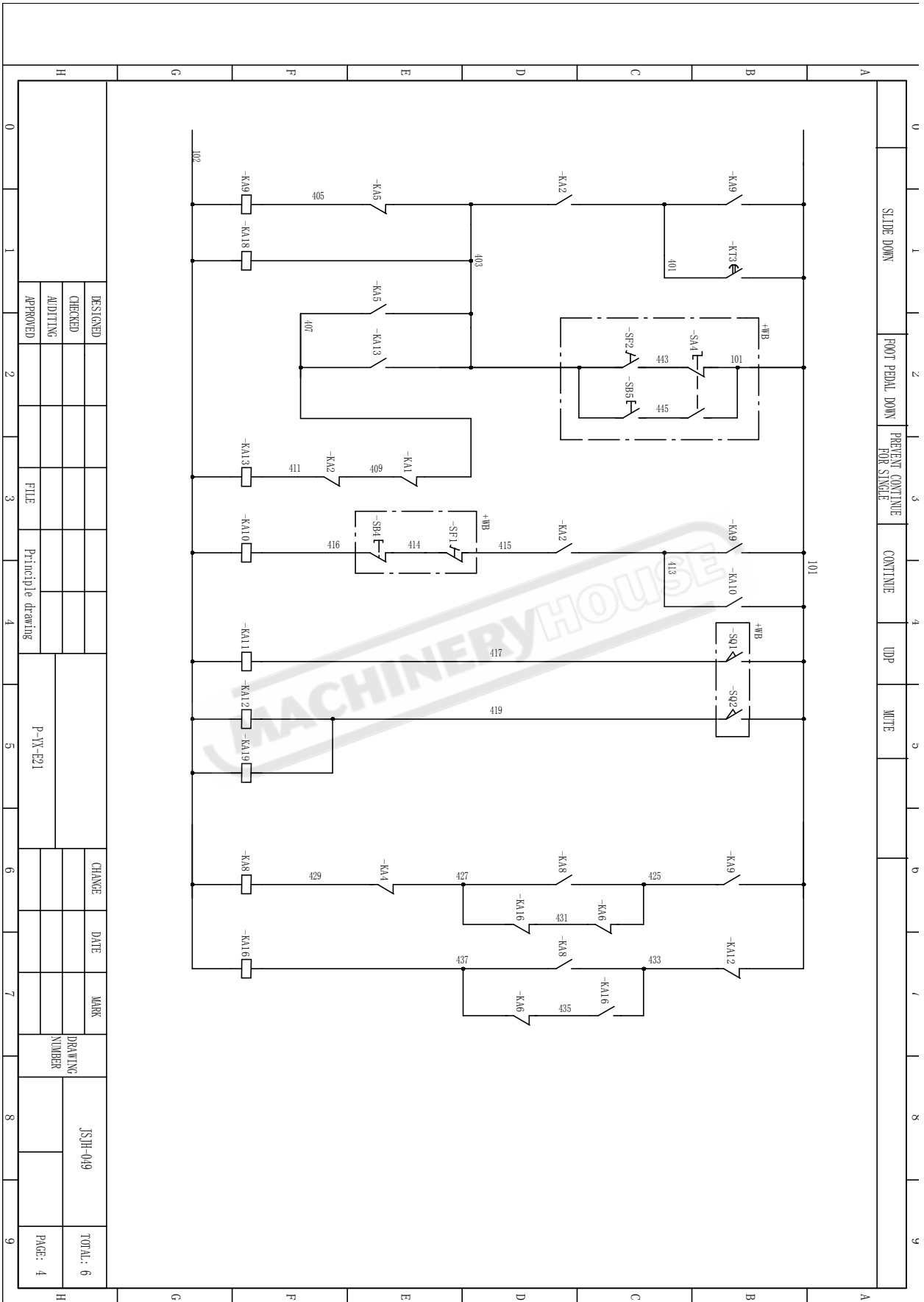

DESIGNED	CHECKED	AUDITING	APPROVED	FILE	Principle drawing	P-YX-221	CHANGE	DATE	MARK	DRAWING NUMBER	JSIH-019	TOTAL: 6	
													PAGE: 4

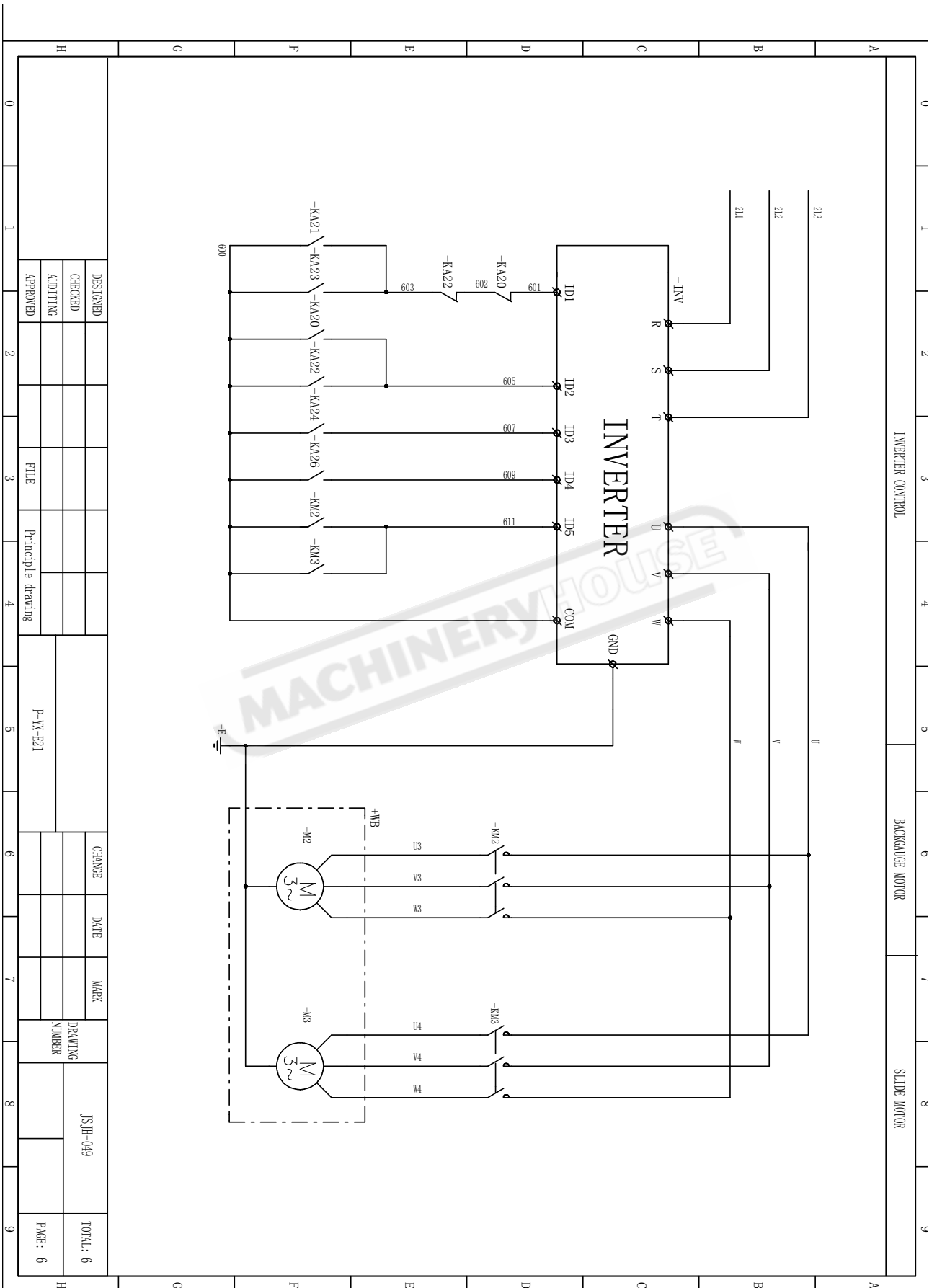

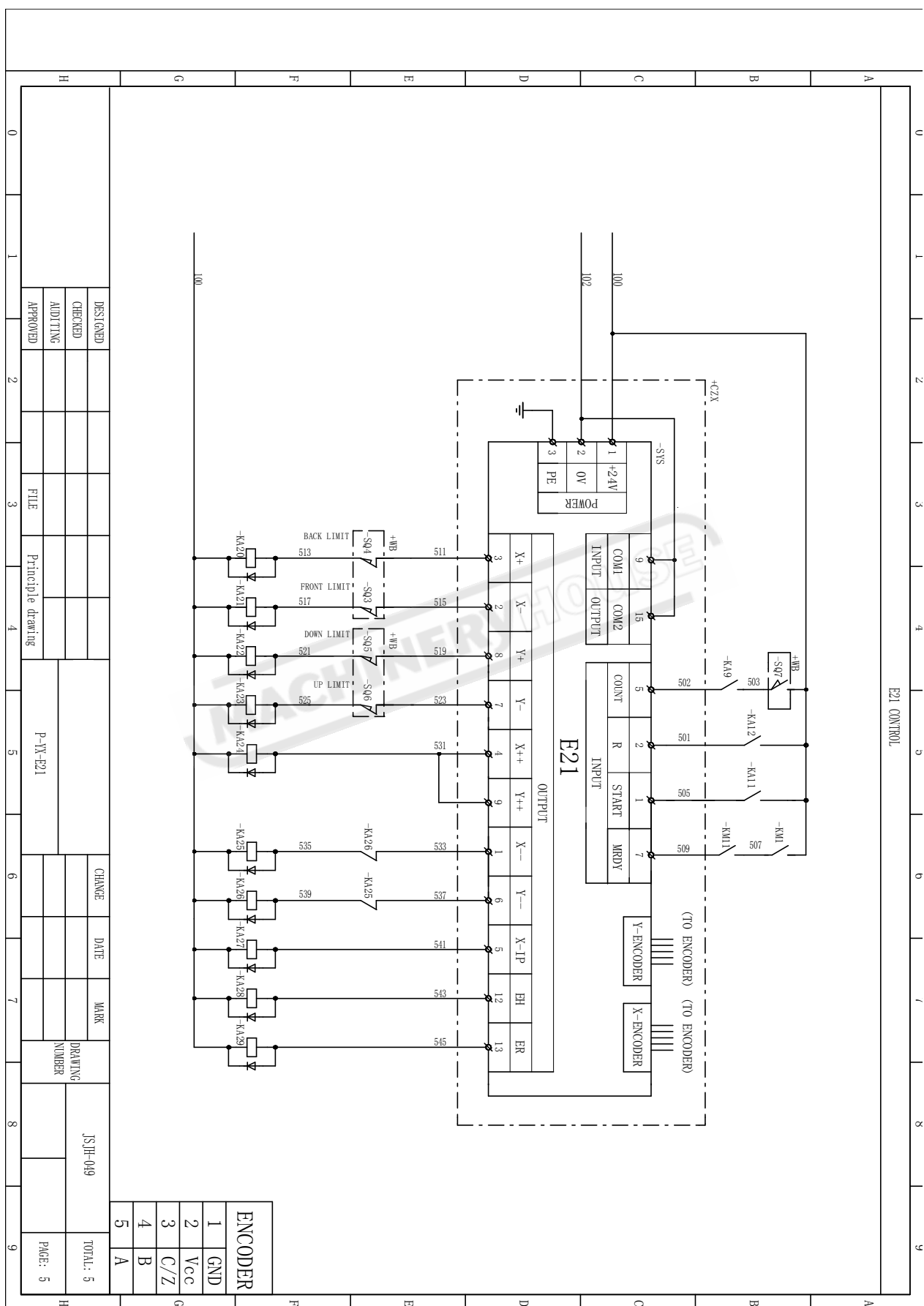

DESIGNED		CHANGE		DATE		MARK		DRAWING NUMBER	JSJH-049	TOTAL: 5
CHECKED										
AUDITING										
APPROVED		FILE	Principle drawing							PAGE: 5

CERTIFICATE OF QUALITY	Total: 3
	Page: 1

This is to certify that the quality of this machine is well qualified after inspection and delivery of it is permitted.

MACHINERYHOUSE

Head of the Inspection Department:

Inspector:

Date:

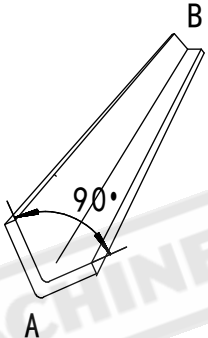
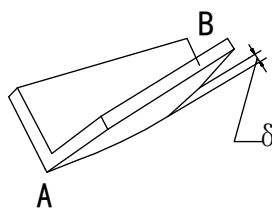
CERTIFICATE OF QUALITY					Total: 3	
					Page: 3	
<p>Geometric precision inspection</p> <p style="text-align: right;">GB/T14349-93</p>						
No.	Inspection item	Schemation drawing	Tool	tolerance		Measurement
P1	Bending angle for workpiece		Pant-ometer	Precision class	At whole length	
				I	$\pm 30'$	
				II	$\pm 1^\circ$	
				III	$\pm 1^\circ 30'$	
P2	Bending straightness of workpiece		Feler Check leveling rule	Precision class	At the length of 1000	
				I	0.30	
				II	0.75	
				III	1.00	



CERTIFICATE OF QUALITY

Total: 3

Page: 2

Recording list of precision inspection

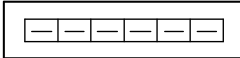
GB/T14349-93

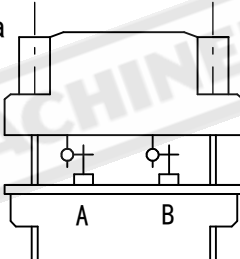
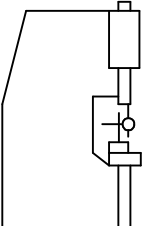
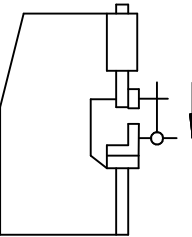
No.	Inspection item	Schemation drawing	Tool	Tolerance	Measurement										
G1	Planeness of worktable	a:  b: 	Level meter	a: Length of worktable Tolerance ≤ 2000 0.06 $>2000-3200$ 0.08 $>3200-4000$ 0.10 $>4000-5000$ 0.12 $>5000-6300$ 0.14 $>6300-8000$ 0.18	a: b:										
				b: Width of worktable tolerance ≤ 500 ≤ 3200 0.02 >3200 0.04		b: 									
				G2 Parallelism, between worktable and horizontal supporting surface meshed with upper die set			a:  b: 	Centi-grade scale	a: Length of worktable tolerance $>1600-2500$ 0.16 $>2500-4000$ 0.18 $>4000-6300$ 0.20	a: b:					
									b: Width of supporting surface Tolerance ≤ 50 0.04 $>50-100$ 0.10		b: 				
									G3 Verreality between worktable and sliding block's				Centi-grade scale Angle bar	Sliding block's stroke tolerance	
														≤ 100 0.20	
														$>100-250$ 0.25	

FoldSafe Pressbrake Safety system.



by cnc automation

Brisbane Australia

Table of Contents

1. Introduction

2. Operating Instructions

3. Error Messages

4. Service Menu

Introduction

FoldSafe is a dual redundant Pressbrake safety system aimed at avoiding injury to the operator of a Pressbrake. It consists of an invisible light curtain mounted vertically in front of the Tool & Die of the pressbrake integrated to the FoldSafe safety controller. When the safety grid is obstructed, the downward movement of the top tool is disabled.

It uses a primary stop function backed up by a secondary stop function with integrated speed and stop distance monitoring.

FoldSafe is a closed loop safety control system that continuously monitors the performance of the machine, what speed it is travelling at, how long it takes to stop etc. In case of malfunction of one of the valves, FoldSafe will execute a secondary stop and ensure safe operation of the press.

Ideally, the secondary stop should be executed via a secondary valve mounted in such a way in the circuit so that in case a pipe burst, the beam will not fall.

The complete safety system consist of

1. Physical guard protecting side entry to the hazardous area. These 2 guards consist of 2 gates mounted on the fixed part of guard that can be opened when necessary.
2. A Rear physical guard guarding the inside area of the pressbrake with safety switches.
3. A light curtain between a transmitter left and a receiver right mounted on 2 physical gates protecting side entry to the hazardous area.
4. An emergency stop button on the footswitch assembly
5. An emergency stop bottom on the control unit of the press.
6. The FoldSafe safety controller

Operating Instructions

Explanation of FoldSafe Keys:

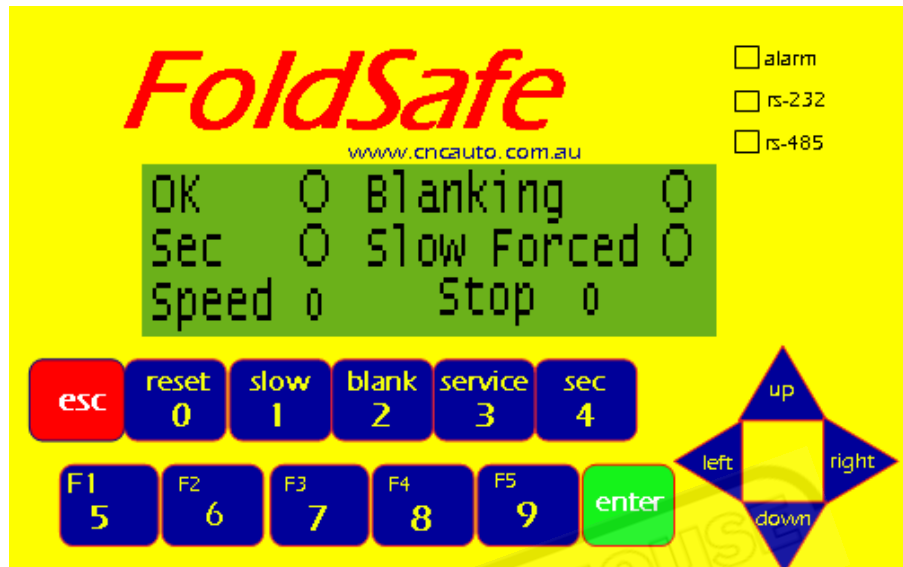

0. RESET Used to reset any fault message.
1. SLOW Used to force the press in a permanent slow mode.
2. BLANK Used to put the blanking feature on. This is necessary when Sheet supports are installed. When sheet supports are removed, the blanking feature has to be disabled by pressing the BLANK button again.
3. SERVICE Used by authorised service/Installation personal to commission the guard, set parameters etc after entering an authorised password
4. SEC/NORM Used to go back to normal mode or exit Service menu

Secondary (Pump) stop test.

When power is applied for the first time, the following screen is displayed:

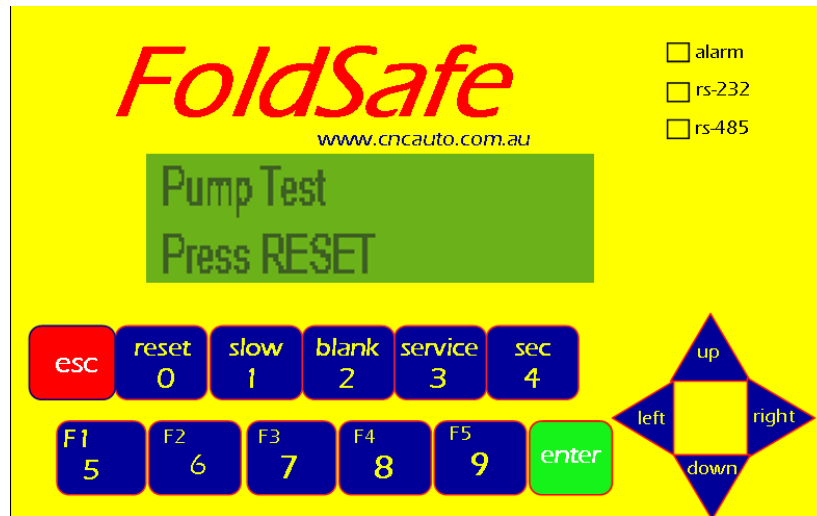

1. Ensure all Emergency stop buttons are released, the rear gate is closed, and press the START button. You should hear the pump running and the green start button should be illuminated.
2. Press and hold the footswitch down
3. FoldSafe will execute a secondary stop test. It will not stop the machine using the normal Down valve but keep the down valve open while closing either the secondary safety valve or stop the pump.
4. FoldSafe measures the distance the beam took to stop.

This is important as it will be needed in case the Primary stop fails.

Secondary stop test Failed.

If the stopping distance for the secondary stop fails, it will display the following screen:

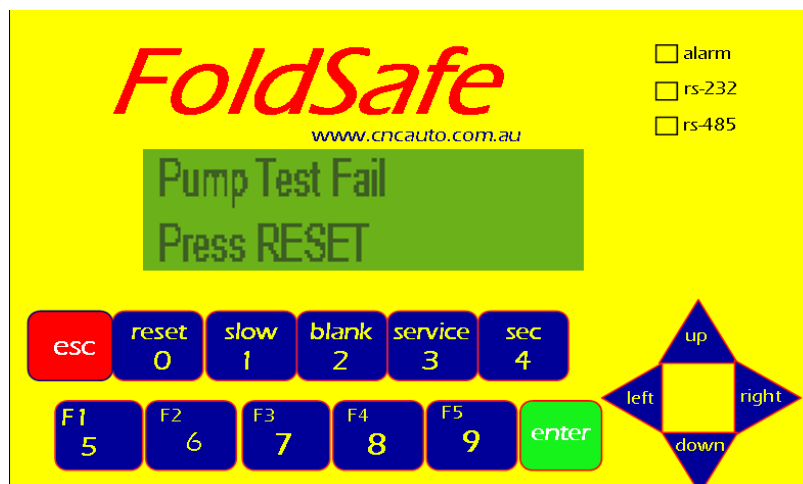

Press reset to repeat this test. If it fails again it will be an unusual occurrence and indicate some problem which needs to be investigated by an authorised service technician.

Secondary stop test Passed.

If the Secondary stop test passed, and the safety curtains are unobstructed, the following screen will be displayed. This is the normal working display:

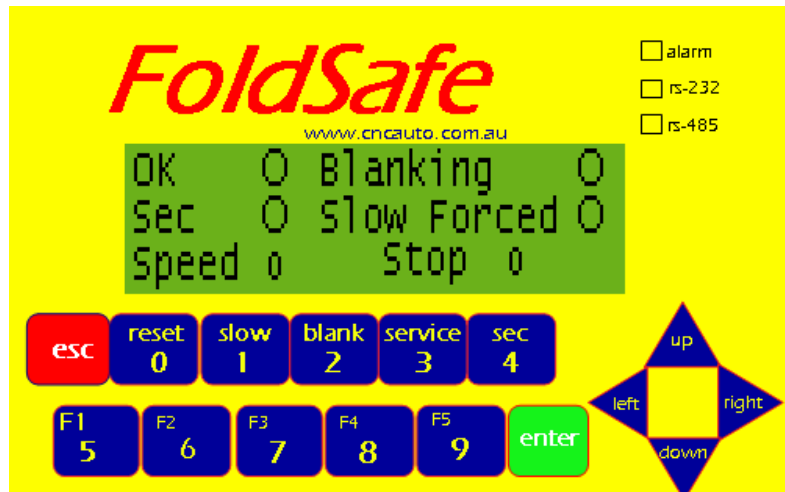

OK	Lit when everything is working normally with a clear unobstructed field
MUTE	Lit when the beam is below the mute point or the system is in a forced slow mode due to a permanent obstruction or stopping distance exceeded.
BLANKING	Lit to indicate the Blanking feature is selected
SLOW FORCED	Lit when FoldSafe is forcing permanent slow speed due to permanent obstruction or a stop distance exceeded or when the operator have selected slow mode.
SPEED	This is the currently measured speed of the beam in mm/sec
STOP	This is the distance that the beam last took to stop in mm

Setting of correct Mute Distance:

- A. The actual mute switch on the machine should be set at the right height so that the top Tool is 9mm away from the material on top of the bottom die when the Mute lamp comes on during a normal downstroke
Set the distance needed to change from fast to slow speed in mm. This can vary from 3mm to more than 20mm.
- B. Setting the distance needed to change from fast to slow speed in mm. This can only be altered by authorised service personnel. This can vary from 3mm to more than 20mm. Do a downstroke and as soon as the press engage slow speed, release the down switch. Measure this gap between the top and bottom tool (Say 18mm) Take the beam up to the top. Do another downstroke and release the footswitch after slow is engage at the point where the mute lamp is lit. Measure this gap (say 9mm) this means the machine took 9mm to change from Fast to slow speed. If the Mute distance setting is too short, slow speed errors can occur.



Encoder error.

When the footswitch is pressed and FoldSafe does not receive any encoder pulses, this could be because of encoder malfunction or maybe the pump is not started or tripped, FoldSafe will disable the primary down valves and display the following message:

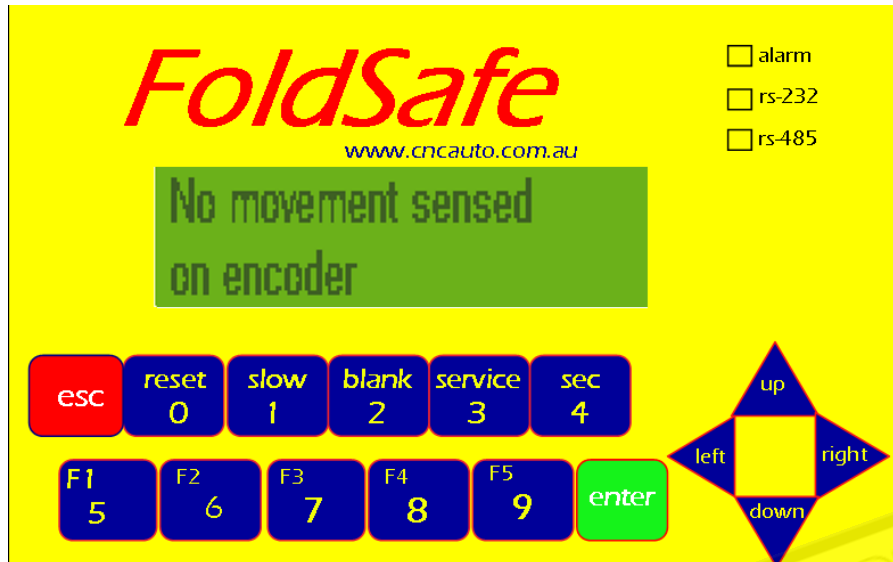

The fault is cleared when the footswitch is pressed again.

Summary - Error Messages

Fault	Action Taken
Pump Test Fail	Press Reset If fault persist, call service
Pump Fail – Footswitch	The footswitch needs to be held until the beam is completely stopped to ensure the secondary stop works
Clear Emergency Stops	The Emergency stop inputs are not clear – Check Emergency Stops and Gates
Slow Stop exceeded	Call Service – Adjustments needed
Slow speed exceeded	Call Service – Adjustments needed
Fast Speed exceeded	Call Service – Adjustments needed
Fast Stop exceeded	Call Service – Adjustments needed
Curtain Inputs different	Curtain error – Call service
No Movement sensed	Most likely fault is Pump is not Started or tripped, faulty relay, valve or encoder Call Service – Adjustments needed

Service Menu

Press the service button. There is a 6 digit password issued only to authorised service engineers.

Scroll using the up/down buttons until the message to be altered is displayed.

Parameters to be set:

1. **Fast Stop** **XXXX mm.** Set the maximum allowed stopping distance from Fast speed here in mm. This is a function of the machine speed and distance from tool to curtain. Recommended 10mm maximum. Curtain distance to be set based on this result.
2. **Slow Stop** **XXXX mm.** Set the maximum allowed stopping distance from Fast speed here in mm. This is a function of the machine speed and distance from tool to curtain. Recommended 3mm maximum.
3. **MuteStop** **XXXX mm.** Set the distance after the mute switch comes on that the beam will stop if the beams were obstructed before the mute point. Recommended setting the same as the mute distance so it will stop at the same time the beams are normally muted.
4. **Fast Speed** **XXXX mm/sec.** Set the maximum Fast speed in mm/sec. Recommended normal fast speed of machine plus 25% (50mm/s plus 25% = 65MM/S)
5. **Slow Speed** **XXXX mm/sec.** Set the maximum slow speed at 10 mm/sec.
6. **Mute Distance** **XXXX mm.** Set the distance needed to change from fast to slow speed in mm. This can vary from 3mm to more than 20mm. The mute switch should be set at the right height so that the top Tool is 9mm away from the material on top of the bottom die when the Mute lamp comes on during a normal downstroke.
7. **Calibration** **XXXX** (Calibration factor for the encoder) This is factory set and should only be altered if a different pulse/rev encoder is used.
8. **No Movement sec** Set the maximum amount of time that the beam can take to move after the footswitch is pressed.

Pressbrake

ESTUN E21 Controller Operation

SINGLE: Common page that is used by anyone who wants to re-write a job.



- X** - (X Back gauge actual position)
- Y** - (Y Ram stroke actual position)
- XP** - (X Program Position) - Back gauge distance from the blade
- YP** - (Y Program Position) - Ram stroke depth. (Test bends must be done)
- DX** - (Distance of Back Gauge Retraction) - Amount the back gauge will retract at mute point
- HT** - (Hold Time) - Dwell time at the bottom of the stroke
- PP** - (Program Pieces) - Number of jobs to be bent
- DLY** - (Delay Retraction) - Time delay in seconds for the back gauge to retract when beam reaches mute point
- CP** - (Completed Pieces) - Amount of jobs that have been completed

Operation: With XP highlighted, type 50.0 and press the enter button. The controller will save this parameter and then highlight YP ready for entry. Continue the same process until all parameters have been entered and then press green program start button. The controller will now find X & Y position. Once it has found position you can start to bend using foot pedal or hand operation.

Example: This job will bend a 50mm return with a Y depth of 38. There is a 50mm back gauge retraction with no delay. There are 20 pieces to bend and 0 pieces have been completed so far. There is a Hold Time of 2 seconds.

PROG: Program management page



This page gives access to all the saved programs, there are 40 programs and ability to save 25 steps for each program.

Operation: Press the **P** (program button) until Program management page has been located. Enter 6 and press enter, this will take you straight to the Product Information Page for program No-6.

PROG: *Product Information page*



PROGRAM6	
ST:	3
PP:	5
CP:	0
DLY:	1.00
HT:	2.00
Mach. not ready	

This page lets you enter parameters for the pieces to be bent.

ST - (Steps) There are 3 steps in this program

PP - (Programed Pieces) - 5 jobs to be bent

CP - (Completed Pieces) 0 pieces completed

DLY - (Delay Retraction) - 1 second time delay for the back gauge to retract

HT - (Hold Time) - 2 seconds dwell time at the bottom of the stroke

Retract Delay - 1 second delay for the back gauge to retract

Operation: With ST highlighted type 3 and press the enter key, this will save parameter and PP will then be highlighted. Continue until all desired parameters have been entered.

Example: This job has 5 pieces to be bent and each piece has 3 bends in it. There are 0 pieces bent yet, the back gauge has a 1 second delay when retracting and a hold time of 2 seconds.

PROG: *Bend information page*

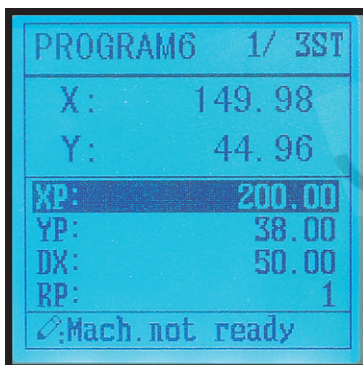

PROGRAM6 1/ 3ST	
X:	149.98
Y:	44.96
XP:	200.00
YP:	38.00
DX:	50.00
RP:	1
Mach. not ready	

This page lets you enter information for each individual bend.

X - (X Back gauge actual position)

Y - (Y Ram stroke actual position)

XP - (X Program Position) - 200mm back gauge distance from the blade

YP - (Y Program Position) - 38 ram stroke depth. (Test bends must be done)

DX - (Distance of Back Gauge Retraction) - 50mm back gauge retraction

RP - (Repeat) - Set to 1 bend. (The amount of times this bend will be done before moving to bend 2)

Operation: With X highlighted, type 200 and press the enter button. The controller will save this parameter and then highlight Y ready for entry. Continue the same process until all desired parameters have been entered. Once bend 1 is complete press , this will take you to bend 2 so parameters can be entered. Once all bends have parameters arrow back to bend 1 and press the green program start button. The controller will now find X & Y position. Once it has found position you can start bend jobs using foot pedal or hand operation.

Example: Program 6 has 3 bends and the screen is on bend 1. Bend 1 has a 200mm return and the ram stroke has a Y value of 38. The back gauge will retract 50mm and bend 1 will be bent once before the controller moves to bend 2.

E21 Operation Manual

(Version: V1.07)



ESTUN AUTOMATION CO., LTD

— Total Solution Supplier // // //

Contents

Preface	1
Chapter 1 Product Overview	2
1.1 Product introduction.....	2
1.2 Operation panel.....	2
1.3 Displayer.....	4
Chapter 2 Operation Instruction	5
2.1 Basic operation procedure.....	5
2.2 Programming.....	6
2.2.1 Single-step programming.....	6
2.2.2 Multi-step programming.....	8
2.3 Parameter setting.....	12
2.4 Manual adjustment.....	14
Chapter 3 Alarm	16
Appendix Common fault and troubleshooting	18

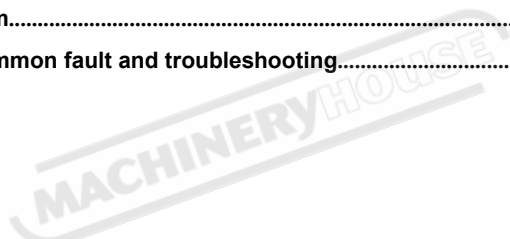

Preface

This manual describes operation of E21 numerical control device and is meant for operators who are instructed for operation of the device. Operator shall read through this manual and know operation requirements before using this device.

Copy right is preserved by ESTUN. It is not allowed to add or delete part or all of the manual content without ESTUN's consent. Do not use part or all of manual content for the third party's design.

E21 device provides complete software control and has no mechanical protection device for operator or the tool machine. Therefore, in case of malfunction, machine tool must provide protection device for operator and external part of the machine tool. ESTUN is not responsible for any direct or indirect losses caused by normal or abnormal operation of the device.

ESTUN preserves the right to modifying this manual in the event of function adding or print error.



Chapter 1 Product Overview

1.1 Product introduction

This product is equipped with press brake machine dedicated numerical control device which is applicable to various users. On the basis of ensuring work precision, the cost of numerical control bending machine is reduced significantly.

Features of this product are listed below:

- Positioning control of back gauge.
- Intelligent positioning control.
- Unilateral and bidirectional positioning which eliminates spindle clearance effectively.
- Retract functions.
- Automatic reference searching.
- One-key parameter backup and restore.
- Fast position indexing.
- 40 programs storage space, each program has 25 steps.
- Power-off protection.

1.2 Operation panel

















Operation panel is shown in Figure 1-1.



Figure 1-1 Operation panel

Functions of panel keys are described in Table 1-1.

Table 1-1 Description of key functions

Key	Function description
	Delete key: delete all data in input area on left bottom of displayer.
	Enter key: confirm the input content. If no content is input, the key has the similar function to direction key  .
	Start key: automatic start-up, top left corner of the key is operation indicator LED. When operation is started, this indicator LED is on.
	Stop key: stop operation, top left corner of the key is Stop indicator LED. When initialize normal start-up and no operation, this indicator LED is on.
	Left direction key: page forward, cursor remove
	Right direction key: page backward, cursor remove
	Down direction key: select parameter downward
	Function switch: switch over different function pages
	Symbolic key: user input symbol, or start diagnosis.
	Numeric key: when setting parameter, input value.
	Decimal point key: when set up parameter, input decimal point.
	Manual movement key: in case of manual adjustment, make adjustment object move in forward direction at low speed.
	Manual movement key: in case of manual adjustment, make adjustment object move in backward direction at low speed.
	High speed selection key: in case of manual adjustment, press this key and press  simultaneously, make adjustment object move in increasing direction at high speed, then press  , make adjustment object move in decreasing direction at high speed.

1.3 Displayer

E21 numerical control device adopts 160*160 dot matrix LCD displayer. The display area is shown in Figure 1-2.

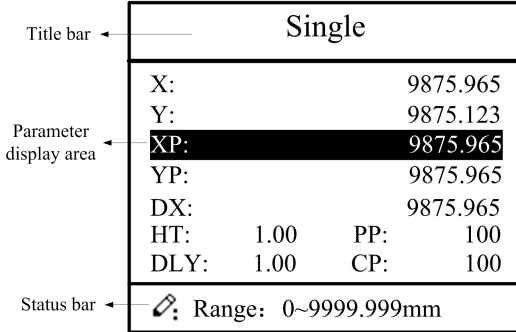

Figure 1-2 Display area

- Title bar: display relevant information of current page, such as its name, etc.
- Parameter display area: display parameter name, parameter value and system information.
- Status bar: display area of input information and prompt message, etc.

The paraphrases of shortening on this page are as shown in Table 1-2.

Table 1-2 The paraphrases of shortening

Shortening	Description
X	The current backgauge position
Y	The current slider position
XP	The desired backgauge position
YP	The desired slider position
DX	Backgauge retract distance
HT	Holding delay
DLY	Retracting delay
PP	Preset workpiece
CP	Current workpiece

Chapter 2 Operation Instruction

2.1 Basic operation procedure

Basic switch over and operation procedure of the device is shown in Figure 2-1.

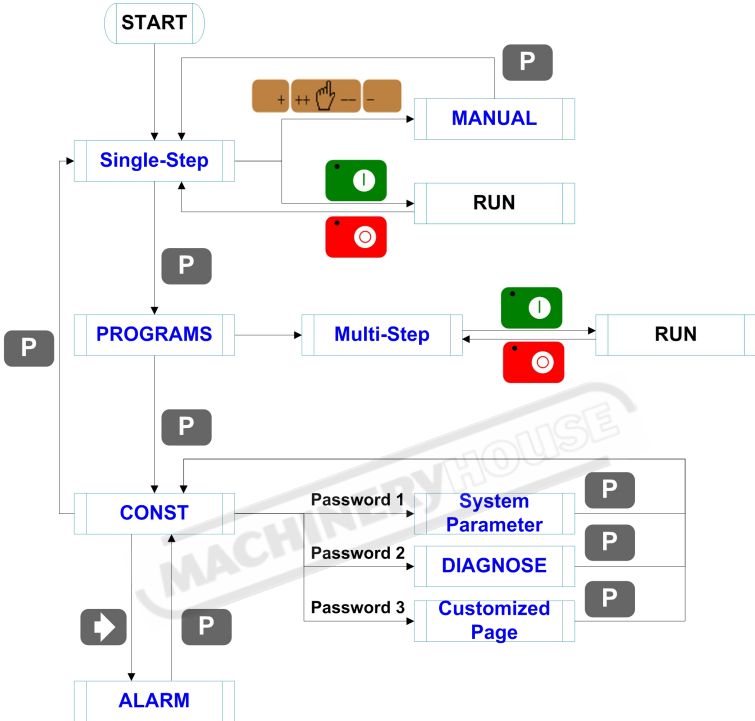
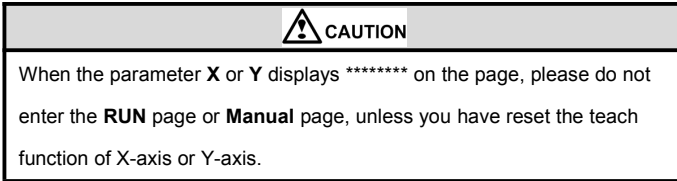

Figure 2-1 Basic Operational Flow

2.2 Programming

The device has two programming methods, which are single-step programming and multi-step programming. User can set up programming according to actual demand.

2.2.1 Single-step programming



Single-step programming is generally used for processing single step to finish work piece processing. When controller is power on, it will automatically enter single-step program page.

Operation steps

Step 1 After starting up, the device will enter setting up page of single-step program automatically, as shown in Figure 2-2.



Single	
X:	200.50
Y:	120.35
XP:	300.00
YP:	130.50
DX:	50.00
HT: 1.00	PP: 100
DLY: 1.00	CP: 100
 Range: Between soft lim.	

Figure 2-2 Single-step program setting page

Step 2 Press , select parameter which needs to be set up, press numerical key to input program value, press  to complete input.

[Note] Parameter can only be set when Stop indicator is on.

Setting range of single step parameter is shown in Table 2-1.

Table 2-1 Set up range of single step parameter

Parameter name	Unit	Set up range	Remarks
X	mm/inch	-	Current position of X axis, unable to be modified.

Parameter name	Unit	Set up range	Remarks
Y	mm/inch	-	Current position of Y axis, unable to be modified.
XP	mm/inch	0~9999.999	Program position of X axis.
YP	mm/inch	0~9999.999	Target position of Y axis.
DX	mm/inch	0~9999.999	Retract distance of X axis.
HT	s	0~99.99	The time between concession signal valid and end hold time output.
DLY	s	0~99.99	In case of single step, delay time for X axis concession.
PP	-	0~9999	Number of preset work piece.
CP	-	0~9999	Number of current work piece.

Step 3 Press , system will execute according to this program, as shown in Figure 2-3.

Single	
X:	9875.965
Y:	9875.123
C:	0
PP:	0 mm



Figure 2-3 Single step operation page





Operation example

On single-step program page, program bending depth to 100.0mm, back gauge position to 80.00mm, retract distance to 50mm, concession waiting time to 2s, holding time to 3s, work piece to 10.

Operation steps are shown in Table 2-2.

Table 2-2 Operation steps of single step example

Operation steps	Operation
Step 1	Press  , select "XP" parameter.
Step 2	Input 80.00 by numerical key.
Step 3	Press  , confirm setting of this parameter.

Operation steps	Operation
Step 4	Press  , select "YP" parameter.
Step 5	Input 100.0 by numerical key.
Step 6	Press  , confirm set up of this parameter.
Step 9	Press  , select "DX" parameter, "DLY" parameter, "HT" parameter, "PP" parameter respectively.
Step 10	Set up parameter to 50mm, 2s, 3s, 10, 0 by numerical key.
Step 11	Press  , system execute according to this program.

2.2.2 Multi-step programming

 **CAUTION**

When the parameter X or Y displays ***** on the page, please do not enter the RUN page, unless you have reset the teach function of X-axis or Y-axis.

Multi-step program is used for processing single work piece of different processing steps, realize consecutive implementation of multi-steps, and improve processing efficiency.

Operation step

- Step 1** Power on, the device displays the single-step parameter page automatically.
- Step 2** Press , switch to program manage page, as shown in Figure 2-4.





























PROGRAMS					0P
					
					
					
					
 1program					1ST

Figure 2-4 Program management page

- Step 3** Press   , select program serial number, or input program number directly, such as input "1".
- Step 4** Press  , enter multi-step program setting page, as shown in Figure 2-5.

PROGRAM1	
ST:	1
PP:	99
CP:	9
DLY:	1.00
HT:	0
Range: 0~25	



Figure 2-5 Multi-step program setting page





Step 5 Press , select multi-step programming parameter which requires set up, input setting up value, press , and the set up takes effect.

Step 6 In completion of set up, press , enter step parameter set page, as shown in Figure 2-6.

PROGRAM1	1/ 5ST
X:	5.000
Y:	12345.000
XP:	9.000
YP:	5.000
DX:	25.00
RP:	54
Range: Between soft lim.	

Figure 2-6 Step parameter set page

Step 7 Press , select step parameter that needs to be set up, input program value, press , and the setup takes effect.

Step 8 Press   to switch over between steps. If the current step is the first step, press  to enter the last page of step parameter setting; if the current step is the last one, press  to enter the first page of step parameter setting.

Multi-step parameter setting range is shown in Table 2-3.

Table 2-3 Multi-step parameter setting range

Parameter name	Unit	Setting range	Remarks
Step number of program	-	0~25	Set up total processing step number of this program

Parameter name	Unit	Setting range	Remarks
Preset work piece number	-	0~9999	Number of work piece to be processed, decreasing piece when more than zero; negative increasing count.
Current work piece number	-	0~9999	Number of finished work piece
Concession delay	s	0~99.99	Time between retract signal and concession execution.
Holding time delay	s	0~99.99	Time between concession signal and end pressurize output
X	mm/inch	-	Current position of X axis, can't be modified;
Y	mm/inch	-	Current position of Y axis, can't be modified;
X target position	mm/inch	0~9999.999	Program position of X axis;
Y target position	mm/inch	0~9999.999	Target position of Y axis;
concession distance	mm/inch	0~9999.999	Distance of X axis concession;
Repeat times	-	1~99	Repeat times required by this step.

Step 9 Press , system will operate according to this program, as shown in Figure 2-7.

PROGRAM 1	Rp: 1/54
X:	5.000
Y:	12345.000
C:	0
PP: 12345	St: 1/ 5

Figure 2-7 Multi-step programming operation page

Operation example

[Background] One work piece requires processing 50 as shown below;

- First bend: 50mm;
- Second bend: 100mm;
- Third bend: the other direction 300mm;







[Analysis] according to work piece and technological conditions of machine tool:



- First bend: X axis position is 50.0mm; Y axis position is 85.00mm, concession 50mm;
- The second bend: X axis position is 100.0mm; Y axis position is 85.00mm, concession 50mm;
- The third bend: X axis position is 300.0mm; Y axis position is 85.00mm, concession 50mm;

Edit processing program of this work piece on No. 2 program.

Operation procedure is shown in Table 2-4.

Table 2-4 Operation steps of multi-step programming example

NO.	Operation
Step 1	On single step parameter setting page, press  to enter program selection page.
Step 2	Input "2", press  , enter multi-step general parameter setting page of program 2.
Step 3	Select "Program step", input "3", press  , the setting takes effect.
Step 4	Select "number of preset work piece", input "50", press  , the setup takes effect.
Step 5	Similar to step 3 and step 4, set "current work piece number", "concession delay" and "pressurize time" to 0, 400, 200 respectively.
Step 6	Press  to enter first step setup page of step parameter.
Step 7	Select "X target position", input 50, press  , the setup takes effect.
Step 8	Select "Y target position", input 85, press  , and the setup take effect.

NO.	Operation
Step 9	Similar to step 7, 8, set up "concession distance" and "repeat times" to 50, 1 respectively.
Step 10	Press  to enter second step setup page of step parameter, the setup method is similar to that of step one.
Step 11	Press  again, to enter third step setup page of step parameter, the setup method is similar to that of step one and step two.

<Note>

- In completion of multi-step programming, return to start step before launching the system; otherwise, the program will start position processing at current step.
- Press left and right direction key to circulate page turning and browsing among all step parameters.
- Program can be called and revised again.
- In completion of processing all work pieces (50 in the example), system stops automatically. Restart directly will start another round of processing 50 work pieces.

2.3 Parameter setting

User can setup all parameters required for normal operation of the system, including system parameter, X axis parameter and Y axis parameter.

Step 1 On program management page, press  to enter programming constant page, as shown in Figure 2-8. On this page, programming constant can be set.

CONST	
mm/inch:	0
中文/English:	1
Release Time:	0.30
Pulse Time:	0.20
Version:	1.10
✎: 0: mm 1:inch	

Figure 2-8 Programming constant page

Range of programming constant setup is shown in Table 2-5.

Table 2-5 Range of programming constant setup

Parameter name	Unit	Range	Default	Remarks
mm/inch	-	0 or 1	0	0: mm, 1: inch
中文/English	-	0 or 1	0	0: Chinese, 1: English
Release Time	s	0 to 99.99	0.3	Continue time of unloading output after starting the system.
Pulse Time	s	0.000 to 1.000	0.200	The duration of the pulse signal.
Version	-	-	-	Software version information, V refers to version. 1: indicates version number. 0: indicates version level.

Step 2 Input password "1212", press  to enter the Teach Page, as shown in Figure 2-9.

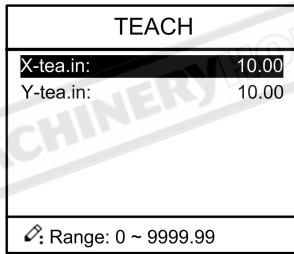
**Figure 2-9** System parameter setting page

Step up parameter, parameter setup range is shown in Table 2-6.

Table 2-6 System parameter setup range

Parameter Name	Unit	Range	Default	Remarks
X-tea.in	mm	0~9999.99	10	In teach enable, input current position of X axis
Y-tea.in	mm	0~9999.99	10	In teach enable, input current position of Y axis

<How to Teach>:



You can directly measure the positions of slider and back gauge. If the measurement is difficult, you can program and operate any one process, and then measure the accomplished workpiece.

Step 3 Press , return to programming constant page.

----End

2.4 Manual adjustment

In single-step mode, axis movement can be controlled by pressing key manually. This method helps user to adjust machine tool and work piece.

Step 1 On single step parameter setup page, press  or  to enter manual page, as shown in Figure 2-10.

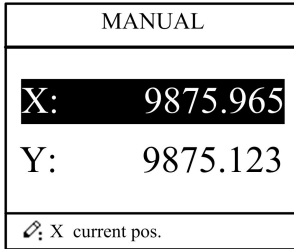





Figure 2-10 Manual page



Step 2 According to your actual requirement, following the above table to adjust the position of the axis.

- If the drive mode of the corresponding axis is **common motor**:

Press Key	Status	Direction	Running Time	Speed
	Stop	increasing	Press time	Slow
	Run	increasing	<ul style="list-style-type: none"> • Press time (if it is less than "Pulse Time") • Pulse Time (If it is less than Press time) 	Slow
	Stop	decreasing	Press time	Slow
	Run	decreasing	<ul style="list-style-type: none"> • Press time (if it is less than "Pulse Time") • Pulse Time (If it is less than Press time) 	Slow
	Stop	increasing	Press time	Slow
	Run	increasing	Press time	Slow
	Stop	decreasing	Press time	Slow
	Run	decreasing	Press time	Slow

<Note>: When the system is on run status, the operation of manual adjustment is just valid for the X-axis.

- If the drive mode of the corresponding axis is **frequency**:

Press Key	Status	Direction	Running Time	Speed
	Stop	increasing	Press time	Slow
	Run	Cannot do it		
	Stop	decreasing	Press time	Slow
	Run	Cannot do it		
	Stop	increasing	Press time	Fast
	Run	Cannot do it		
	Stop	decreasing	Press time	Fast
	Run	Cannot do it		

Step 3 Press  return to single step parameter setting page.

---End



Chapter 3 Alarm

The device can detect internal or external abnormality automatically and send out alarm prompt. Alarm message is available on alarm list.

Step 1 On programming management page, press  to enter programming constant page.

Step 2 On programming constant page, press  to enter "Alarm history" page to view all alarm history.

As shown in Figure 3-1, the latest 6 alarms, alarm number and causes can be viewed on this page.

ALARM RECORD	
A.22	Encoder failure

Figure 3-1 Alarm history page

Alarm history and message is shown in Table 3-1.

Table 3-1 Alarm number and alarm message

Alarm number	Alarm name	Alarm description
A.02	XPos < minimum	Move X-axis forwards in Manual Movement.
A.03	XPos > maximum	Move X-axis backwards in Manual Movement.
A.04	YPos < minimum	Move Y-axis forwards in Manual Movement.
A.05	YPos > maximum	Move Y-axis backwards in Manual Movement.
A.06	X out of lmt.	Re-teach the position of X-axis.
A.11	Count reached shut-down	Rerun, the alarm is cleared automatically.
A.12	Beam is not on upper dead point	Step on the Foot Up Switch, moving the slider to the TDC, and the alarm will be cleared automatically.
A.13	X Un-teachIn	Re-teach the position of X-axis.
A.14	Y Un-teachIn	Re-teach the position of Y-axis.

Alarm number	Alarm name	Alarm description
A.21	Oil pump not started	Check whether the pump signal is connected, and check whether the pump switch is on.
A.22	Encoder failure	Check whether the encoder wiring is normal.
A.25	Drive mode err	Reprogram the Drive Mode for X-axis and Y-axis.
A.26	X Stop Err	Check whether the back gauge motor is run normally.
A.27	Y Stop Err	Check whether the slider motor is run normally.
A.28	X V2 Err	Check whether the back gauge motor is run normally.
A.29	X V3 Err	Check whether the back gauge motor is run normally.
A.30	Y V2 Err	Check whether the slider motor is run normally.
A.31	Y V3 Err	Check whether the slider motor is run normally.
A.32	XPos < 0	Move X-axis forwards to the setting range in Manual Movement.
A.33	YPos < 0	Move Y-axis forwards to the setting range in Manual Movement.
A.41	Parameter storage error	Back to factory for repairing

----End

Appendix Common fault and troubleshooting

Fault phenomena	Trouble shooting
The screen don't display when power on.	<ul style="list-style-type: none"> • The terminal of power supply wiring is error. Follow the nameplate to rewire. • The source voltage is too low. • The connector is not connected well.
The back gauge motor doesn't run when X-axis is operated, but the slider motor runs.	The wires of these two motor are in reverse, please rewire.
The motor doesn't run when operating.	<ul style="list-style-type: none"> • Check whether the machine is impeded, or whether the slider is back to TDC • Check whether the motor wire is connected well.
The motor can't mutually convert from high to low	<ul style="list-style-type: none"> • Check whether the signal is in effect, or whether frequency converter is normal. • Check whether parameter Mute Dis. is programmed correctly.
The step can't be changed in Multi-Step mode.	Check the START terminal is connected to +24V when the slider is on TDC.
The counter doesn't work in Multi-Step mode.	Check the START terminal is connected to +24V when the slider is on TDC.
Lose control of the system	<ul style="list-style-type: none"> • Check whether the encoder cable is connected well. • Check whether the motor direction wiring (X+, X-, Y+, Y-) is correct.
The actual position of X-axis or Y-axis is unchanged or unshown.	Check whether the encoder cable is connected well or correctly.



MACHINERYHOUSE

ESTUN AUTOMATION CO., LTD

Add: 155 Jiangjun Road, Jiangning Development Zone,
Nanjing 211106, P.R.China

TEL: 025-52785866

FAX: 025-52785992

WEB: www.estun.com

Email: info@estun.com



www.estun.com

ESTUN

WARNING

General Machinery Safety Instructions

Machinery House
requires you to read this entire Manual before using this machine.

- 1. Read the entire Manual before starting machinery.** Machinery may cause serious injury if not correctly used.
- 2. Always use correct hearing protection when operating machinery.** Machinery noise may cause permanent hearing damage.
- 3. Machinery must never be used when tired, or under the influence of drugs or alcohol.** When running machinery you must be alert at all times.
- 4. Wear correct Clothing.** At all times remove all loose clothing, necklaces, rings, jewelry, etc. Long hair must be contained in a hair net. Non-slip protective footwear must be worn.
- 5. Always wear correct respirators around fumes or dust when operating machinery.** Machinery fumes & dust can cause serious respiratory illness. Dust extractors must be used where applicable.
- 6. Always wear correct safety glasses.** When machining you must use the correct eye protection to prevent injuring your eyes.
- 7. Keep work clean and make sure you have good lighting.** Cluttered and dark shadows may cause accidents.
- 8. Personnel must be properly trained or well supervised when operating machinery.** Make sure you have clear and safe understanding of the machine you are operating.
- 9. Keep children and visitors away.** Make sure children and visitors are at a safe distance for you work area.
- 10. Keep your workshop childproof.** Use padlocks, Turn off master power switches and remove start switch keys.
- 11. Never leave machine unattended.** Turn power off and wait till machine has come to a complete stop before leaving the machine unattended.
- 12. Make a safe working environment.** Do not use machine in a damp, wet area, or where flammable or noxious fumes may exist.
- 13. Disconnect main power before service machine.** Make sure power switch is in the off position before re-connecting.
- 14. Use correct amperage extension cords.** Undersized extension cords overheat and lose power. Replace extension cords if they become damaged.
- 15. Keep machine well maintained.** Keep blades sharp and clean for best and safest performance. Follow instructions when lubricating and changing accessories.
- 16. Keep machine well guarded.** Make sure guards on machine are in place and are all working correctly.
- 17. Do not overreach.** Keep proper footing and balance at all times.
- 18. Secure workpiece.** Use clamps or a vice to hold the workpiece where practical. Keeping the workpiece secure will free up your hand to operate the machine and will protect hand from injury.
- 19. Check machine over before operating.** Check machine for damaged parts, loose bolts, Keys and wrenches left on machine and any other conditions that may effect the machines operation. Repair and replace damaged parts.
- 20. Use recommended accessories.** Refer to instruction manual or ask correct service officer when using accessories. The use of improper accessories may cause the risk of injury.
- 21. Do not force machinery.** Work at the speed and capacity at which the machine or accessory was designed.
- 22. Use correct lifting practice.** Always use the correct lifting methods when using machinery. Incorrect lifting methods can cause serious injury.
- 23. Lock mobile bases.** Make sure any mobile bases are locked before using machine.
- 24. Allergic reactions.** Certain metal shavings and cutting fluids may cause an allergic reaction in people and animals, especially when cutting as the fumes can be inhaled. Make sure you know what type of metal and cutting fluid you will be exposed to and how to avoid contamination.
- 25. Call for help.** If at any time you experience difficulties, stop the machine and call you nearest branch service department for help.

WARNING

Hydraulic Pressbrake Safety Instructions

Machinery House
requires you to read this entire Manual before using this machine.

- 1. Maintenance.** Make sure the Pressbrake is turned off and disconnect from the main power supply and make sure all moving parts have come to a complete stop before any inspection, adjustment or maintenance is carried out. Ensure the beam retaining bolts on the bottom of piston rams are checked to be tight on a regular maintenance schedule.
- 2. Pressbrake Condition.** Pressbrake must be maintained for a proper working condition. Never operate a Pressbrake that has low oil levels, damaged or worn parts. Scheduled routine maintenance should be performed on a scheduled basis.
- 3. Tooling Condition.** Never operate a Pressbrake with damaged or badly worn tooling. Replace if required.
- 4. Pump Direction.** Pump rotation must be in arrow direction otherwise the pump will be damaged.
- 5. Hand Hazard.** Do not insert or extend your hands in between bending tools, under any circumstances, while the machine is in operation mode. Serious injury can occur.
- 6. Gloves & Glasses.** Always wear leather gloves and approved safety glasses when using this machine.
- 7. Authorized and trained personnel.** The machine must be operated by authorized and trained personnel. The machine is designed to be operated by a single user. Using the machine with more than one operator is forbidden, except for certain maintenance situations.
- 8. Power outage.** In the event of a power failure during use of the machine, turn off all switches to avoid possible sudden start up once power is restored.
- 9. Work area hazards.** Keep the area around the Pressbrake clean from oil, tools, objects & chips. Pay attention to other persons in the area and know what is going on around the area to ensure unintended accidents. Do not access the rear of machine, while the machine is working
- 10. Guards.** Operate machine only with all protective devices and guarding in place and operational. Never remove, defeat or bypass. Any presence-sensing safeguarding used must have regular Safety integrity tests and records kept. These records must be kept for 5 years or for the life of the plant and be handed to any person that you relinquish control of the plant to. Tests include stop time measurements, safety distance calculations and inspections, with operator checks and periodic maintenance checks. (WHS Regulation 226)
- 11. Overloading Pressbrake.** Do not exceed the rated capacity of the pressbrake. Refer to the manual for correct capacity and bending chart.
- 12. Warning Labels.** Take note of any warning labels on the machine and do not remove them.
- 13. Protective fence.** Do not bridge the safety limit switch of the side and rear protective fences.
- 14. Support arms.** Do not use support arms for intermediate storage of workpieces.
- 15. Operation.** During the bending process, the workpiece may leap up. Therefore, the material must be handled carefully.
- 16. Emergency stop.** Use the emergency stop button in case of any emergency.
- 17. Level machine.** Level the machine on a flat concrete surface by using a spirit level.
- 18. Floor load for Installation.** The permissible floor load, where the machine is to be installed, must be accounted for.
- 19. Hearing protection and hazards.** Always wear hearing protection as noise generated from machine and workpiece can cause permanent hearing loss over time.
- 20. Heating Material.** Heating metal with a torch while the metal is in the bending brake will weaken the fingers.
- 21. Pinching.** Prevent pinching by lowering the bending brake fingers when not in use.
- 22. Call for help.** If at any time you experience difficulties, stop the machine and call your nearest branch service department for help.

PLANT SAFETY PROGRAM

NEW MACHINERY HAZARD IDENTIFICATION, ASSESSMENT & CONTROL

Hydraulic Pressbrake

Developed in Co-operation Between A.W.I.S.A and Australia Chamber of Manufactures
This program is based upon the Safe Work Australia, Code of Practice - Managing Risks of Plant in the Workplace (WHSA 2011 No10)

Item No.	Hazard Identification	Hazard Assessment	Risk Control Strategies <small>(Recommended for Purchase / Buyer / User)</small>
B	CRUSHING	LOW	Secure & support work material on table. Care must be taken when removing blades. Regular maintenance Schedule must be maintained
C	CUTTING, STABBING, PUNCTURING	MEDIUM	Wear gloves to prevent cuts from sharp material offcuts.
D	SHEARING	MEDIUM	Hands should be kept clear of moving parts. Isolate power to machine prior to any checks or maintenance. Do not adjust or clean until machine has fully stopped. Machine must be fitted with guarding, (see workcover authority principles to machine guarding for guidelines).
F	STRIKING	MEDIUM	Ensure guards are secured properly. Wear safety glasses. Stand clear of falling offcuts. Keep clear of bending material.
H	ELECTRICAL	MEDIUM	Machine should be installed & checked by a Licensed Electrician. All electrical enclosures should only be opened with a tool that is not to be kept with the machine.
O	OTHER HAZARDS, NOISE.	LOW	Wear hearing protection as required.
Plant Safety Program to be read in conjunction with manufactures instructions			



www.machineryhouse.com.au



www.machineryhouse.co.nz

Authorised and signed by:

Safety officer:

Manager:

Revised Date: 25th Sept 2015